

ME231

Three-phase multifunctional smart meter V1.0



Contents

1.Product description	1
2.Data display	4
3.Accuracy and certification	5
4.Connection	6
4.1. Power supply	7
4.2. Voltage and current input	7
4.3. RS485	9
4.4. Relay output	9
4.5. Digital input	9
5.Operation and interface display	10
5.1. Key function display description:	10
5.2. Meter start interface	10
5.3.Meter display mode switching	11
5.4. Measure menu interface	12
5.4.1. Measure menu-Instantaneous value interface	13
5.4.2. Measure menu-Energy interface	14
5.4.3. Measure menu-Harmonics interface	15
5.4.4. Measure menu- Phasor diagram interface	16
5.4.5. Measure menu- Demand interface	16
5.4.6. Measure menu- Unbalance interface	17
5.4.7. Measure menu- Max.&Min. interface	17
5.5. Settings menu interface	19
5.5.1. Settings menu -Power Grid interface	20
5.5.2. Settings menu -Current sensor interface	21
5.5.3. Settings menu -Tariff interface	22
5.5.4. Settings menu -Demand interface	23
5.5.5. Settings menu -Communication interface	24
5.5.6. Settings menu -HMI interface	25
5.5.7. Settings menu -Password interface	26
5.6. Reset menu interface	27
5.7. Device information menu interface	28

1.Product description

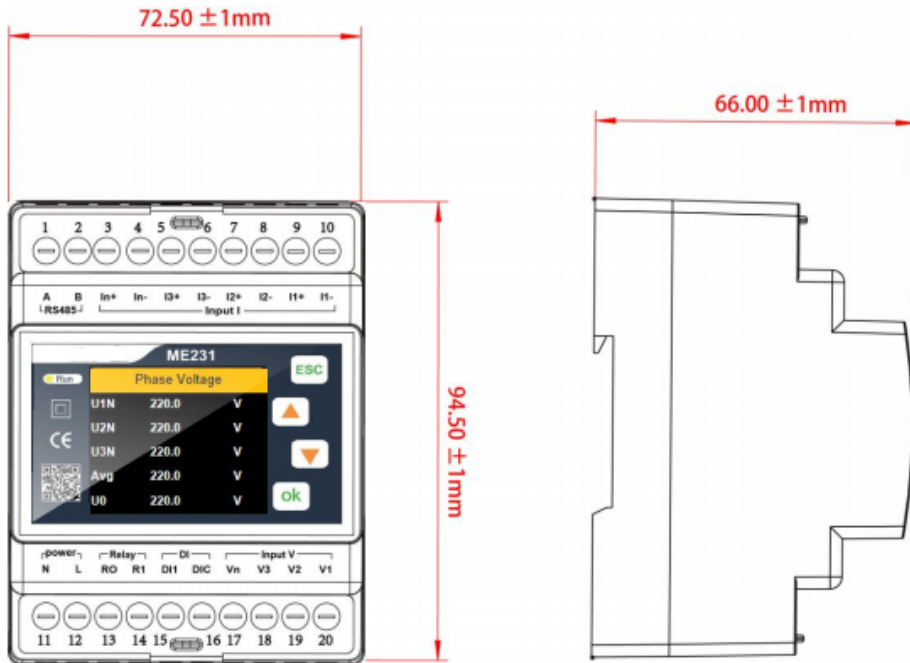

(Dimensional Drawing)

ME231 Model naming Rules

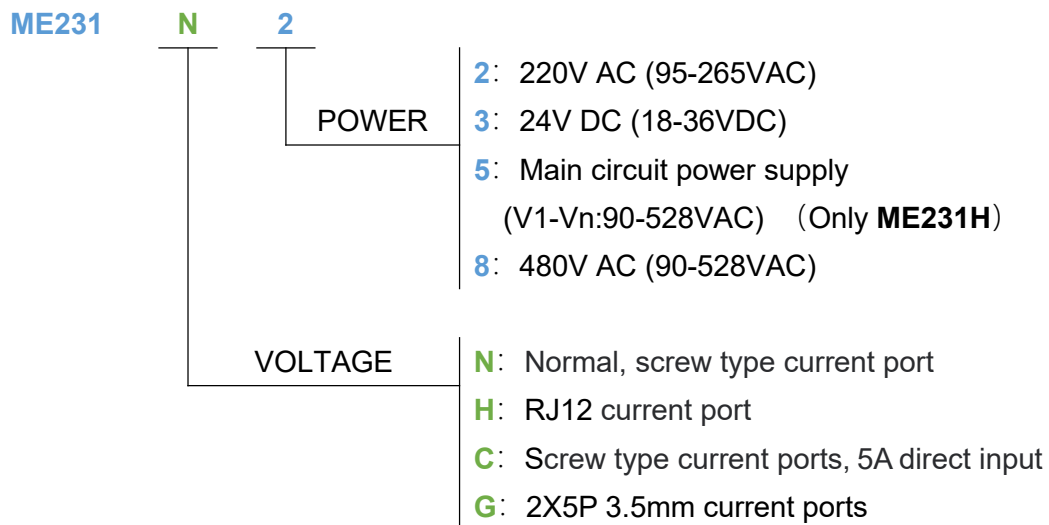

The ME231 is a DIN-Rail three-phase multifunctional smart meter that supports externally connected with open type Rogowski coil or voltage type CT, it can realize none dismantling wire test, simplify test steps, save construction cost, and is more convenient for engineering test as well as the inspection and maintenance of distribution system.

The ME231 support systems of single-phase and three-phase. It can measure multiple electrical parameters such as current, voltage, power factor, harmonics, power, energy and other electrical parameters of L1,L2,L3.The standard RS485 communication interface can be compatible with various configuration systems through the standard MODBUS-RTU protocol.

Description		
Type	DIN rail	
Model	ME231	
Current sensor type	Rogowski coil Voltage-output current clamp	
Advantage	Suitable for wide current range, no dismantling measurement	
Wiring system	3P4W 4CT, 3P4W 3CT, 3P3W 3CT, 3P3W 2CT, 1P3W, 1P2W	
Application field	Power analysis Tariff meter	
Display screen	1.77 inch TFT screen display	
Weight	259g	
Dimension	L*W*D: 9.45*7.25*6.6CM	
Color	White	
Current		
Channel input voltage range	0-900mVAC peak,636 mV RMS	
Measurement range	Different current sensors have different ranges	
Rcoil	50mV/kA@50Hz(0-12000A),@60Hz(0-10000A) 85mV/kA@50Hz(0-7000A),@60Hz(0-6000A) ...	
VCT	0~99999A	
Voltage		
Channel input voltage range	0~600VAC Phase Voltage	
Maximum range	720VAC Phase Voltage	
Digital Signal		
Relay output	One way electromagnetic relay output, contact capacity:3A 30V DC, 3A 250V AC	
Digital input	One way dry contact input, optocoupler isolation (5kVrms)	
Communication		
RS485 communication	One way RS485 communication interface Interface type: two wire half duplex Communication baudrate: 2400bps ~ 38400bps Protocol: Modbus RTU	
Power supply		
Power Supply	ME231N2	ME231N3
	95~265VAC/110~370VDC, 45~60Hz	
Maximum power consumption	3.5VA	

2.Data display

Instantaneous value	
Phase Voltage	U1,U2,U3,AVG
Line Voltage	U12,U23,U31,AVG
Current	I1,I2,I3,AVG,IN
Grid Frequency	F1,F2,F3,Σ
Power Factor PF	PF1,PF2,PF3,Σ
Fundamental power factor DPF	DPF1,DPF2,DPF3,Σ
Active power	P1,P2,P3,Σ
Reactive power	Q1,Q2,Q3,Σ
Apparent power	S1,S2,S3,Σ
Energy	
Active energy Pos.	EP1,EP2,EP3,Σ
Active Energy Neg.	EP1,EP2,EP3,Σ
Reactive Energy Pos.	EQ1,EQ2,EQ3,Σ
Reactive energy Neg.	EQ1,EQ2,EQ3,Σ
Apparent Energy	ES1,ES2,ES3,Σ
Tariff Energy	ET1,ET2, ET3,ET4, ET5,ET6
Harmonics	
Voltage Harmonic Distortion	THD (Total harmonic percentage), TOHD (Odd total harmonic percentage), TEHD (Even total harmonic percentage), phase L1.L2.L3 1-50th harmonic percentage, phase ABC 1-50th harmonic voltage value
Voltage Harmonic Value	
Current Harmonic Distortion	THD (Total harmonic percentage) , TOHD (Odd total harmonic percentage), TEHD (Even total harmonic percentage), phase L1.L2.L3 1- 50th harmonic percentage, phase ABC 1-50th harmonic current value
Current Harmonic Value	
Phasor diagram	
Phasor diagram	between voltage and current
Phase Sequence	voltage and current
Voltage Angle	U1,U2,U3
Current Angle	I1,I2,I3
UI Angle	UI1,UI2,UI3
Demand	
Demand	P,Q,S
Active power DMD Max.	P and Time
Reactive power DMD Max.	Q and Time
Apparent power DMD Max.	S and Time
Unbalance	
Voltage unbalance	Negative Sequence, zero Sequence
current unbalance	Negative Sequence, zero Sequence
Max.&Min.	
Phase Voltage	U1,U2,U3,AVG
Line Voltage	U12,U23,U31,AVG
Current	I1,I2,I3,AVG,IN
Active power	P1,P2,P3,Σ
Reactive power	Q1,Q2,Q3,Σ
Apparent power	S1,S2,S3,Σ

3.Accuracy and certification

Measuring accuracy	
current measurement accuracy	0.1%+Accuracy of current sensor
Voltage measurement accuracy	±0.2%(60V~600V AC)
Grid frequency	±0.01%(45~65Hz)
Power factor	±0.005
Active and apparent power	IEC62053-22 level 0.5S
Reactive power	IEC62053-21 level 1S
Active energy	IEC62053-22 level 0.5S
Reactive energy	IEC62053-21 level 1S
Environment condition	
Operating temperature	-20℃~+70℃
Storage temperature	-40℃~+85℃
Humidity range	5~95% RH, 50℃(non-condensing)
Class of pollution	2
Over voltage capability	CAT III 1000V, It is suitable for distribution system below 277 / 480VAC
Insulation strength	IEC61010-1
Altitude	3000m Max
Antipollution level	IP20 (Meet the standard of IEC 60629)
Quality guarantee period	12 months
EMC (electromagnetic compatibility)	
Electrostatic discharge	Level IV(IEC61000-4-2)
Radiated immunity	Level III (IEC61000-4-3)
EFT Electrical fast burst immunity	Level IV (IEC61000-4-4)
Surge immunity	Level IV (IEC61000-4-5)
Conducted disturbance immunity	Level III (IEC61000-4-6)
Power frequency magnetic field immunity	0.5mT (IEC61000-4-8)
Conduction and radiation	Class B (EN55022)
Measurement standard	
EN 62052-11, EN61557-12, EN 62053-21, EN 62053-22, EN 62053-23, EN 50470-1, EN 50470-3, EN 61010-1, EN 61010-2, EN 61010-031	

4.Connection

The meter is equipped with rich interfaces to realize different functions.

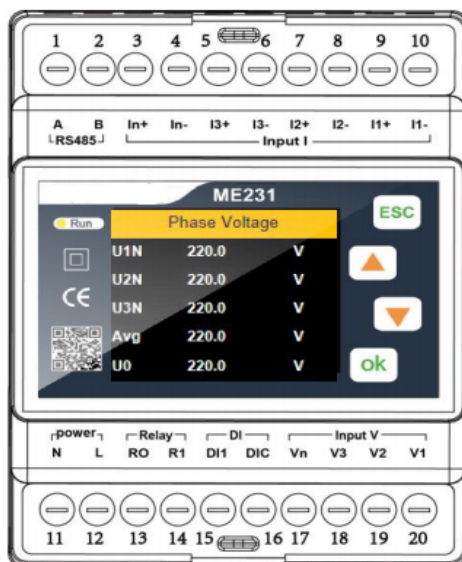

Point number	Point name	Point function	Point type	Remarks
1	A	RS485 communication A	RS485	RS485 communication
2	B	RS485 communication B		
3	In+	Phase N current input positive	Current input	Current channel
4	In-	Phase N current input negative		
5	I3+	Phase L3 current input positive		
6	I3-	Phase L3 current input negative		
7	I2+	Phase L2 current input positive		
8	I2-	Phase L2 current input negative		
9	I1+	Phase L1 current input positive		
10	I1-	Phase L1 current input negative		
11	N	Power supply (-)	Power supply	Range 95~265VAC, 45~60Hz 110~260VDC
12	L	Power supply (+)		
13	R0	Relay common contact	Relay output	One relay output with normally open
14	R1	Relay normally open contact		
15	DI1	Digital input channel 1	Digital input	ONE way dry contact input
16	DIC	Digital channel common terminal		
17	Vn	N-phase voltage input	Voltage input	Measurement voltage input channel
18	V3	L3-phase voltage input		
19	V2	L2-phase voltage input		
20	V1	L1-phase voltage input		

4.1. Power supply

The meter adopts external power supply mode, without internal direct power supply. The power supply voltage range is 95 ~ 265VAC / 110 ~ 260VDC, 45 ~ 60Hz, and the maximum power consumption is 3.5VA.

- Do not connect the meter with the cable live.
- Before connecting the power supply, make sure that the power supply voltage is within the required range, otherwise the meter can not work normally.

4.2. Voltage and current input

The ME231 supports 6 kinds of wiring methods:3P4W_4CT,3P4W_3CT,3P3W_3CT,3P3W_2CT,1P3W,1P2W.

Before connecting the measurement wires, please correctly configure the wiring method of the meter.

- The actual wiring mode of the meter must be consistent with that of the internal configuration of the meter.
- 3P4W_4CT requires 4 current sensors and the N phase current is measured by the sensors
- 3P4W_3CT requires 3 current sensors, the N phase current is obtained by calculation
- 3P3W_3CT requires 3 current sensors, the L2 phase current is measured by the sensors
- 3P3W_2CT requires 2 current sensors, the L2 phase current is obtained by calculation
- The phase sequence of voltage and current must follow the phase sequence of ABC, otherwise the meter will display the phase sequence error of voltage and current.
- When using the current sensor, the direction of the current arrow on the sensor must be consistent with the actual current flow direction, that is, the current arrow of the sensor points to the load end.

The ME231 connection mode of voltage and current is as follows:

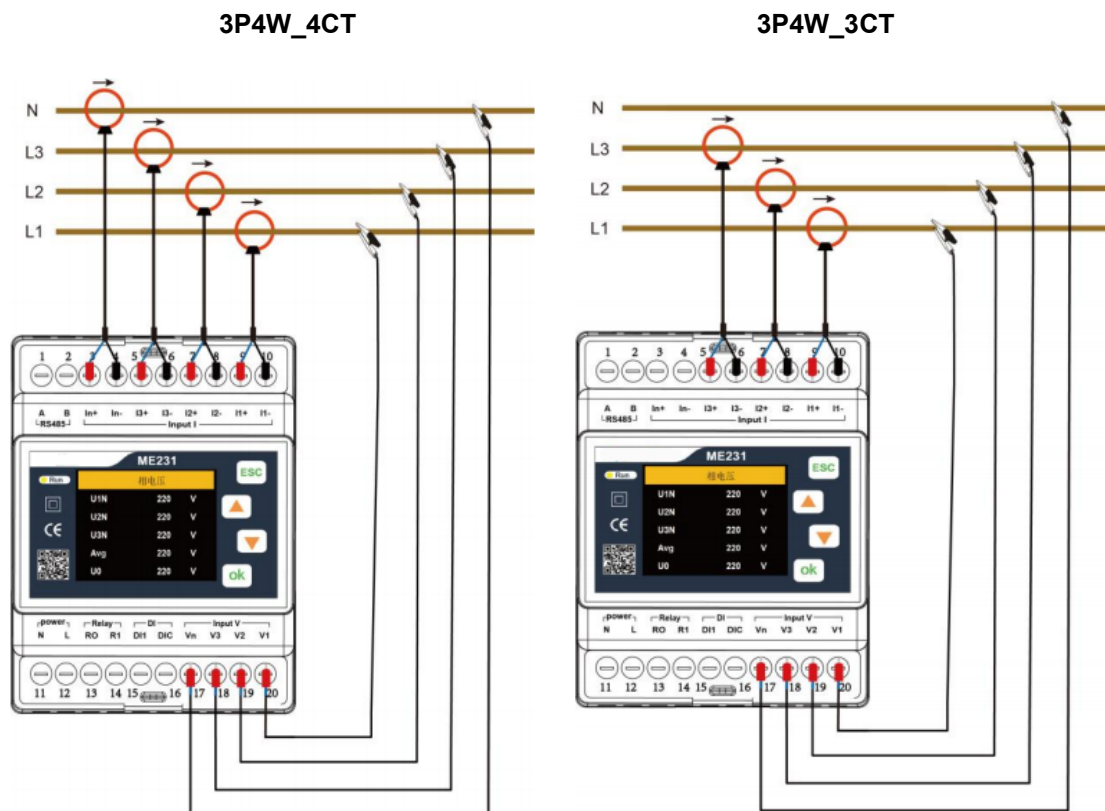

3P3W_3CT

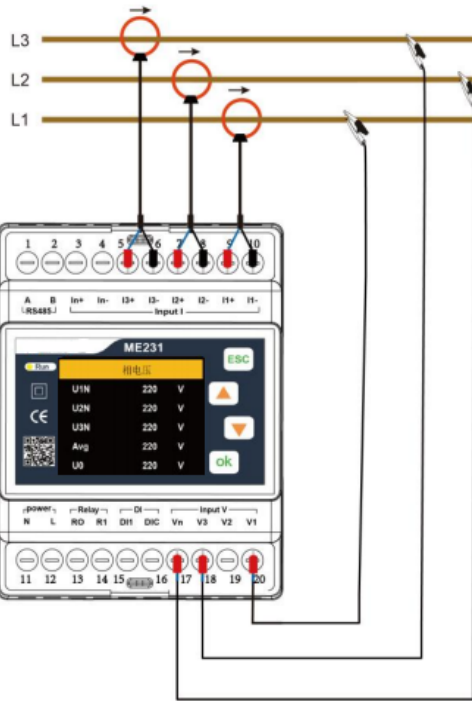

3P3W_2CT

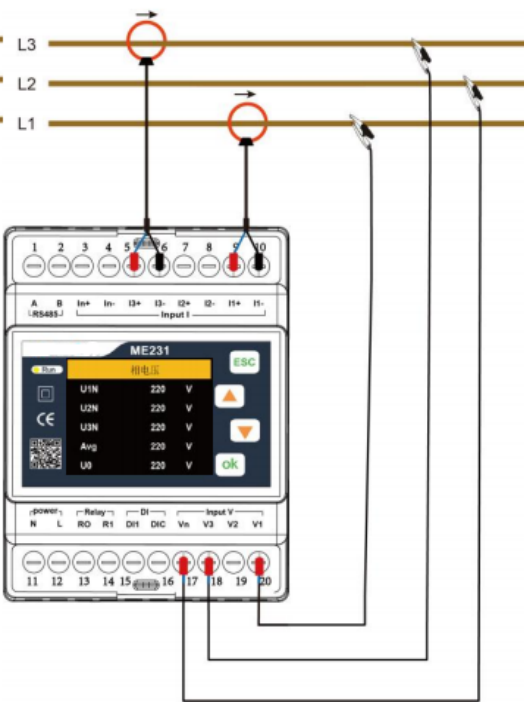

1P3W

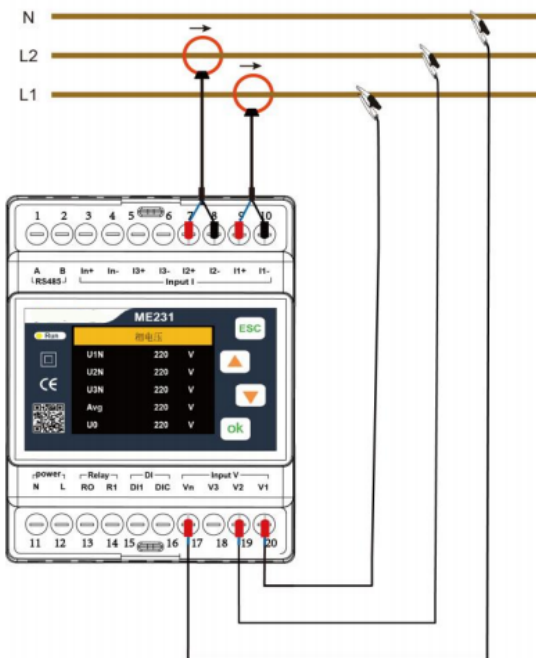

1P2W

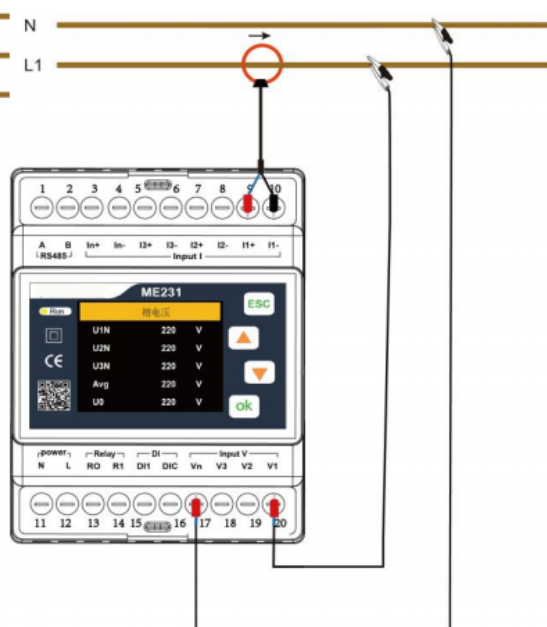

4.3. RS485

The meter is equipped with a RS485 communication interface, which supports Modbus RTU protocol. The RS485 communication port requires shielded twisted pair connection, which is connected in the form of daisy chain. In the case of long distance and high speed, a 120 Ω resistor should be parallel connected at both ends of the daisy chain.

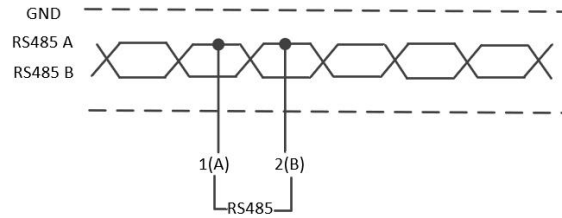

4.4. Relay output

The meter is equipped with a relay output and has one contact, normally open. The identification of terminal blocks is: R1, R0, where R0 is the common contact, R1 is the normally open contact. The relay output can be controlled by RS485 / Modbus protocol. The closed state of normally open contact of relay is displayed on the display interface of electric meter. Maximum load capacity of relay: 3A 30V DC, 3A 250V AC

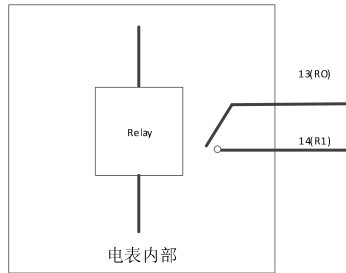

继电器输出接口连接示意图

4.5. Digital input

The meter is equipped with one digital switch inputs, which are connected by passive dry contact. The identification of terminal blocks is: DI1, DIC, where DIC is the common contact. The status of one digital switch input can be read through RS485 / Modbus protocol, and the digital switch input status can be displayed in the electric meter display interface.

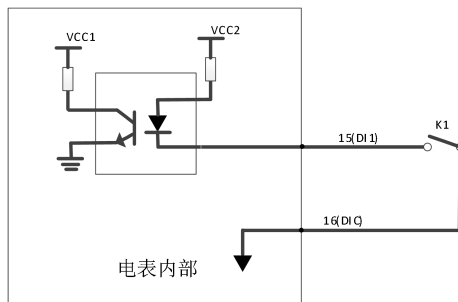

数字输入接口连接示意图

5.Operation and interface display

This section is used to describe the display of the interface and key combination operation, as well as the configuration of the equipment.

The four buttons of the meter are shown below:



5.1. Key function display description:

Key symbols	describe
	Return key: used to exit the current operation interface.
	Up key: used to switch the interface display and Long press to switch displacement,
	Down key: used to switch the interface display and Long press to switch displacement,
	Confirm key: used to confirm the operation and switch the numerical display when setting.

5.2. Meter start interface

After the meter is powered on and started, the following interface will be displayed.

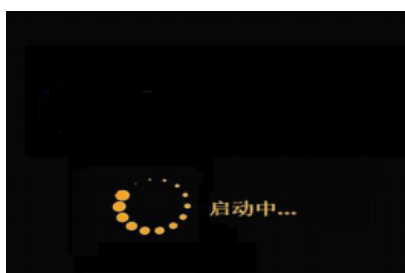

Opening interface

2s

Phase Voltage		
U1N	220.0	V
U2N	220.0	V
U3N	220.0	V
Avg	220.0	V
U0	220.0	V

Default interface

Main menu-measure menu-instantaneous value menu-phase voltage interface

5.3.Meter display mode switching

Under the main menu of the ME231, there are four secondary menus: Measure menu, Settings menu, Reset menu and Device information menu. The switch between menus is shown in the figure below:

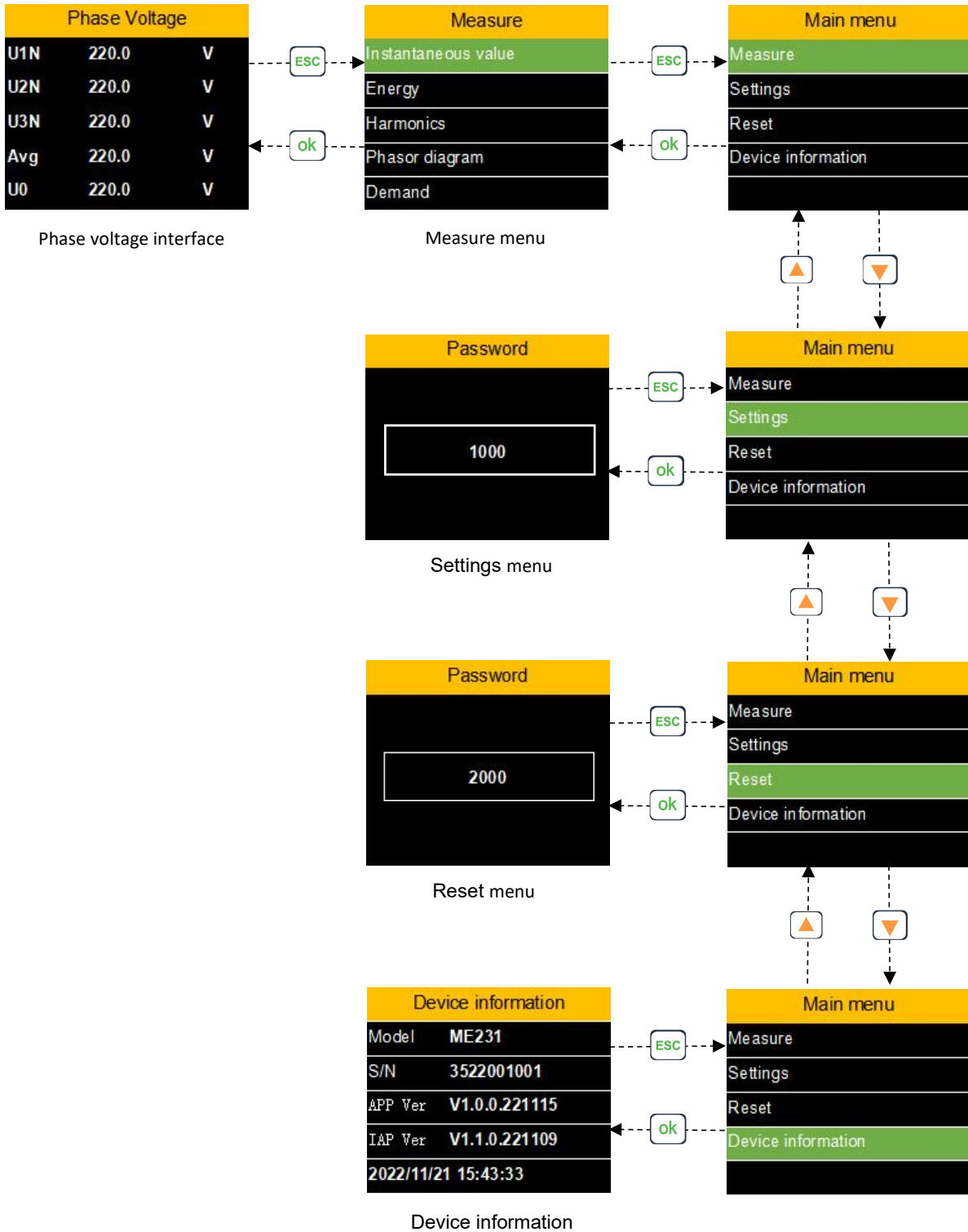

5.4. Measure menu interface

There are 7 sub-menus under the Measure menu: Instantaneous Value, Energy, Harmonics, Phase Diagram, Demand, Imbalance, Max.&Min.

By pressing  or , To switch the display of the interface.

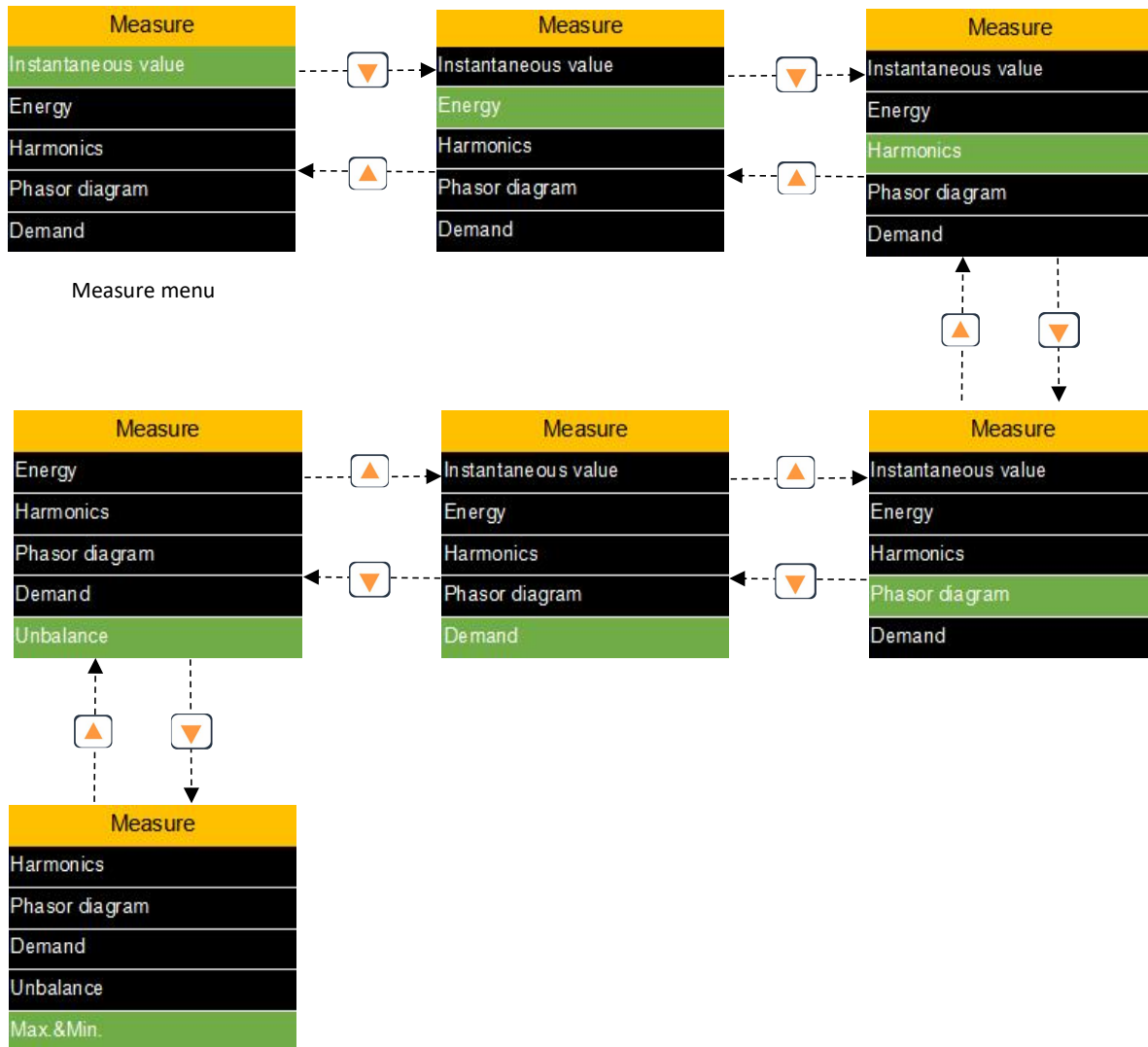

5.4.1. Measure menu-Instantaneous value interface

Instantaneous value interface is used to display: voltage, current, power, power factor, frequency and other data.

By pressing  or , To switch the display of the interface.





5.4.2. Measure menu-Energy interface

Energy interface is used to display: Active energy, Reactive energy, Apparent energy.

By pressing  or , To switch the display of the interface.



5.4.3. Measure menu-Harmonics interface

Harmonics interface is used to display: Voltage harmonics, current harmonics and other data. By pressing  or , ESC or OK key to switch the interface display.

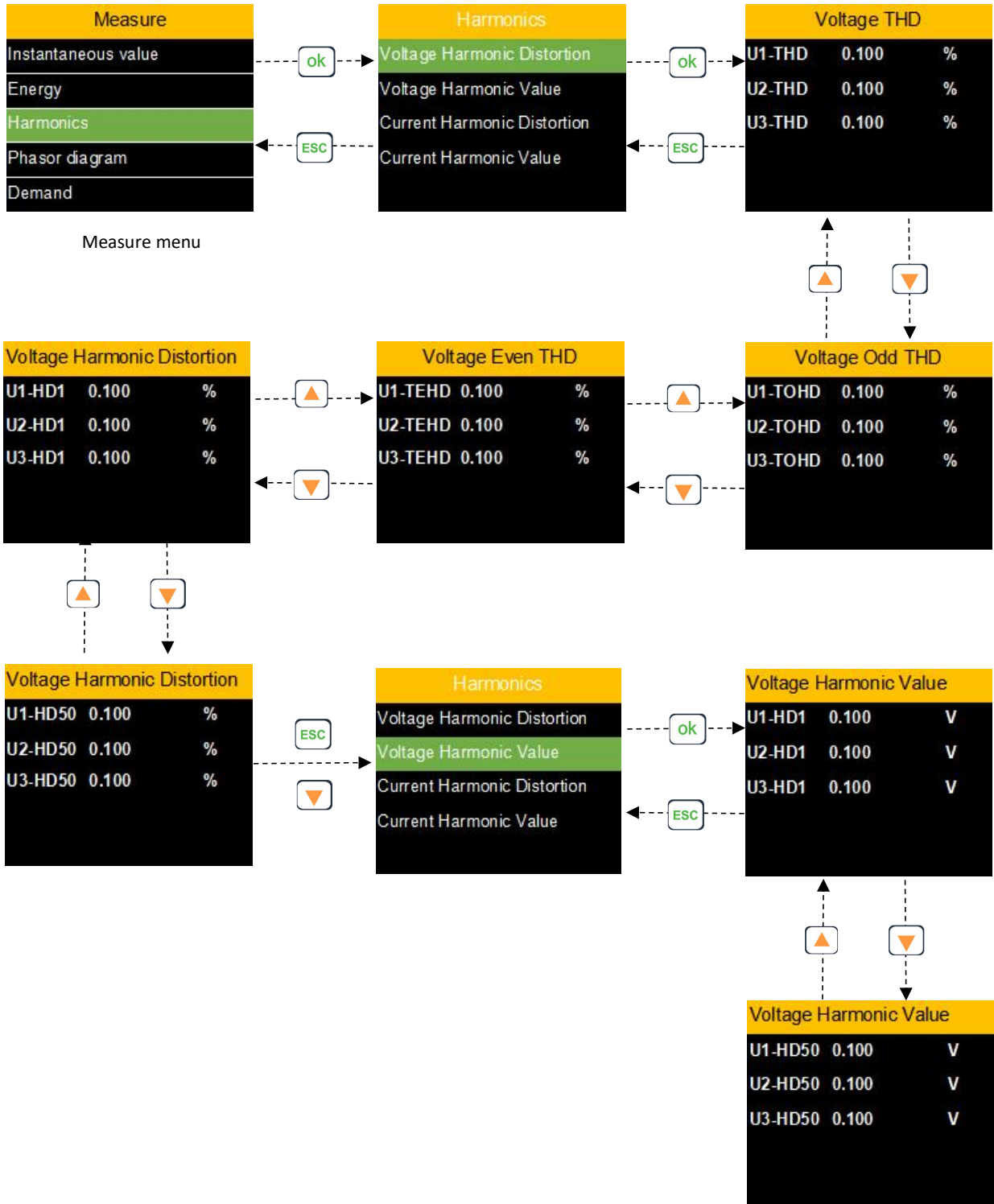

5.4.4. Measure menu- Phasor diagram interface

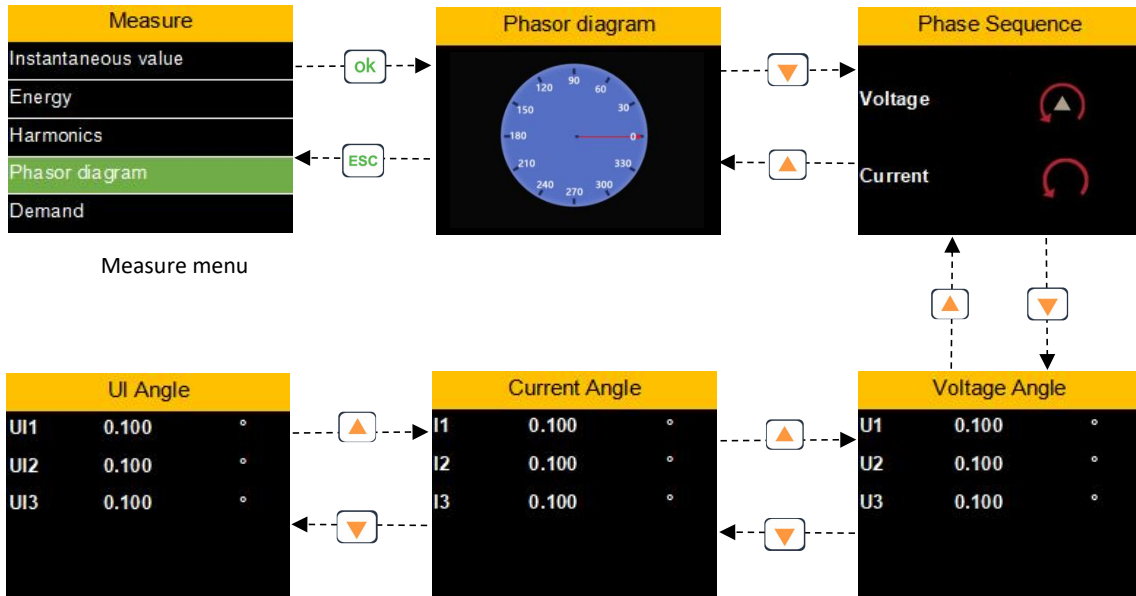

Phasor diagram interface is used to display: Phasor diagram, Phase Sequence, Angle and other data.

By pressing  or , To switch the display of the interface.



5.4.5. Measure menu- Demand interface

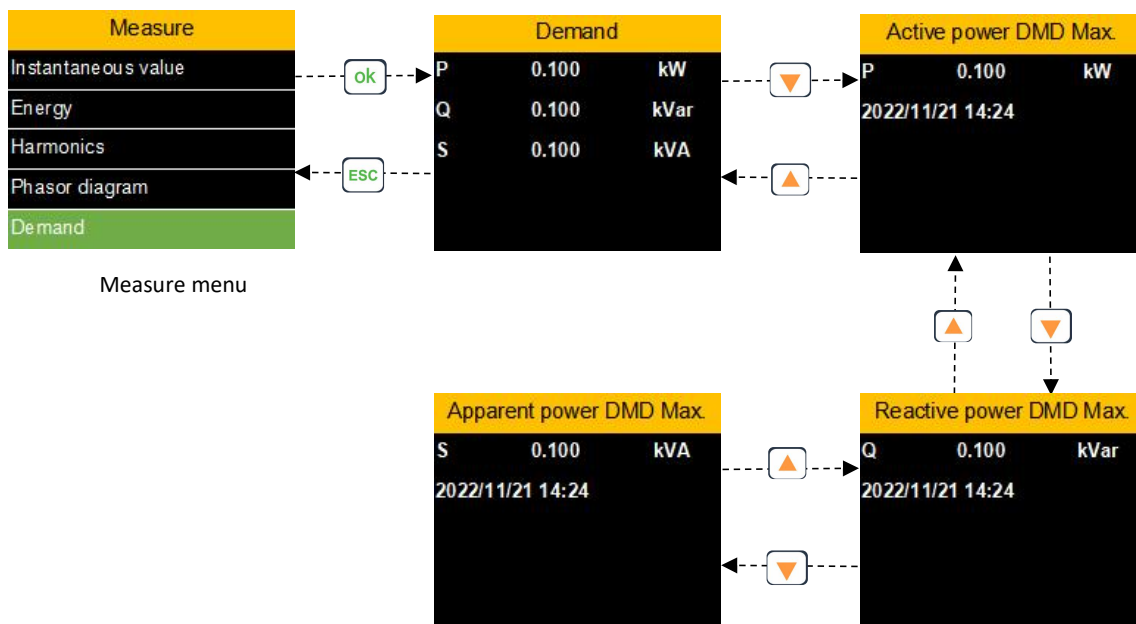

Demand interface is used to display: Active power, Reactive power, Apparent power

DMD. By pressing  or , To switch the display of the interface.



5.4.6. Measure menu- Unbalance interface

Unbalance interface is used to display: Voltage unbalance, current unbalance. By pressing

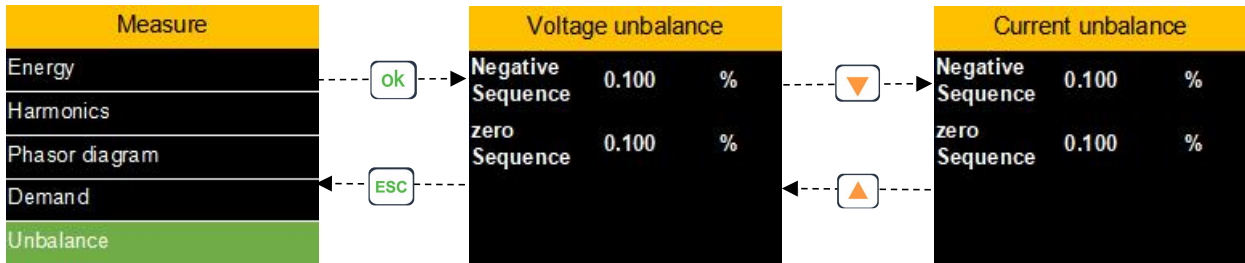

 or , To switch the display of the interface.



Measure menu

5.4.7. Measure menu- Max.&Min. interface

Max.&Min. interface is used to display: Voltage Max.&Min., Current Max.&Min. and other



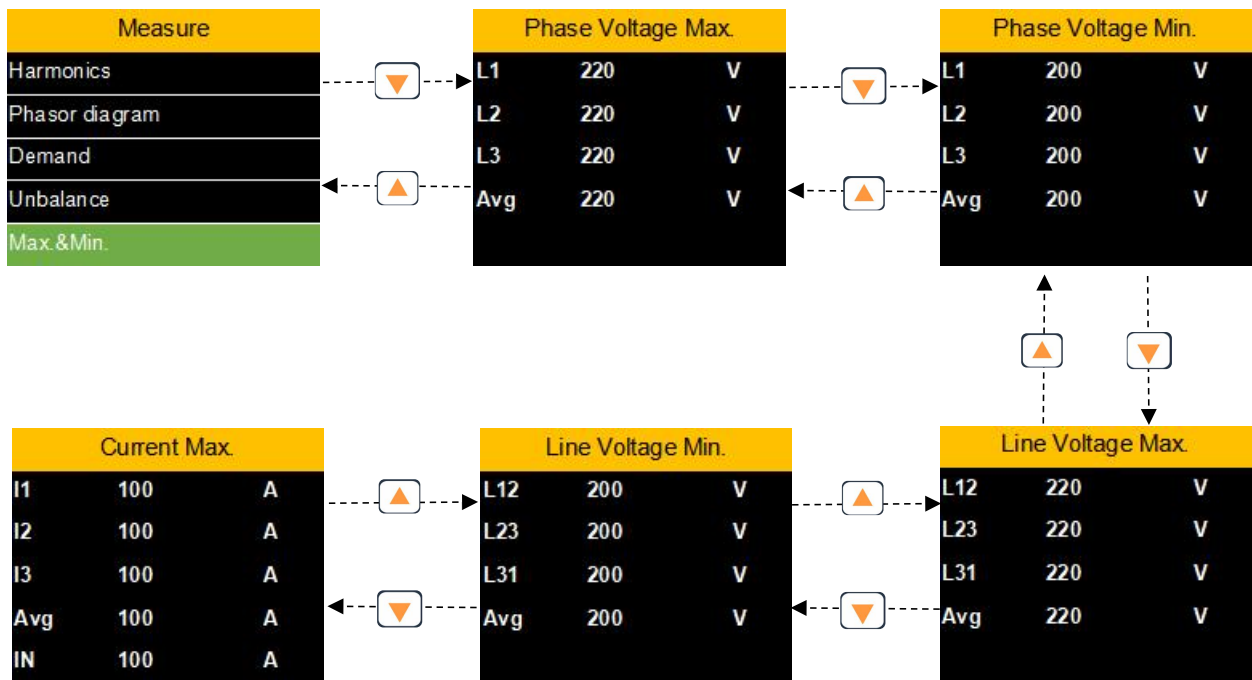

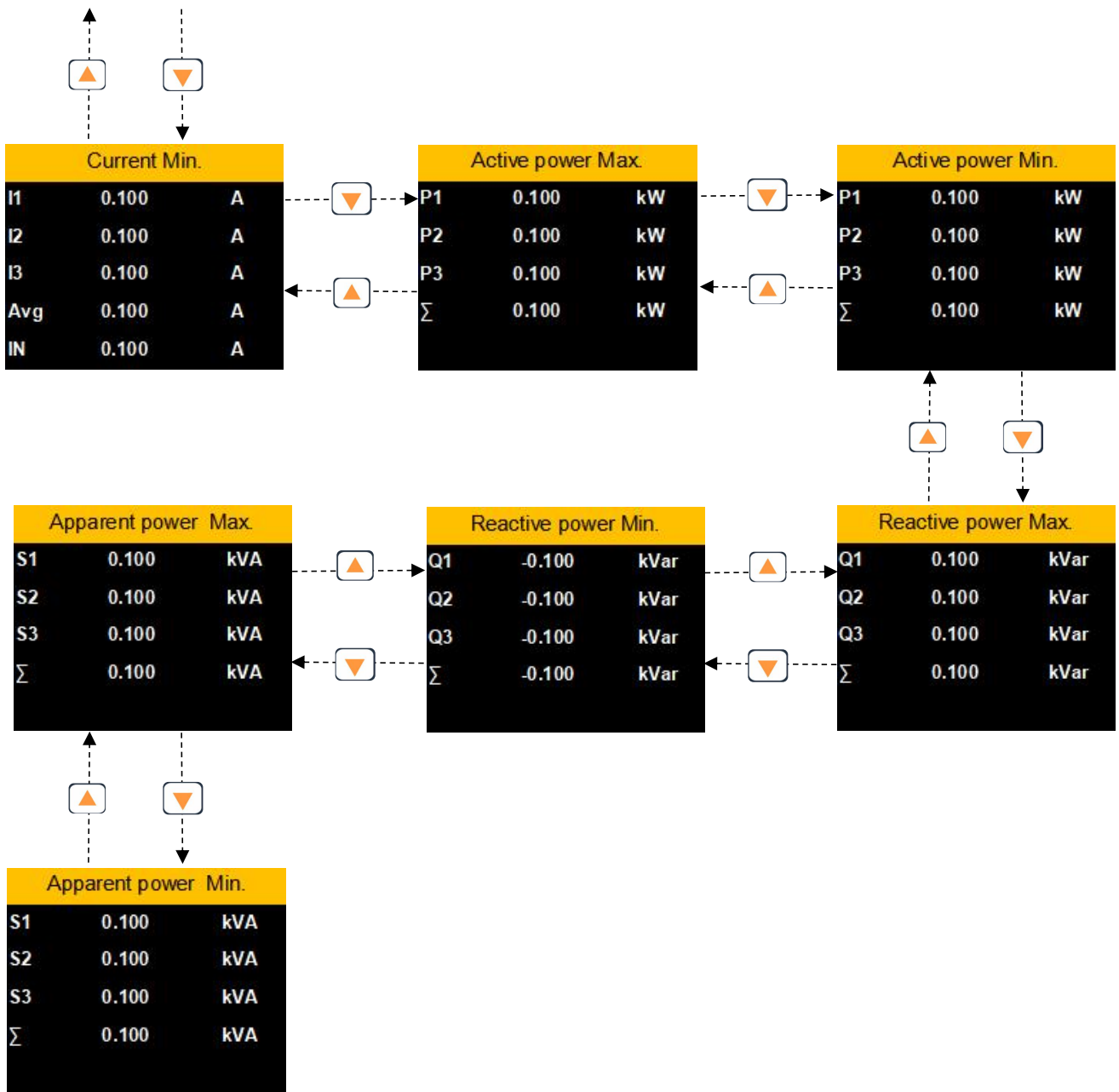
data. By pressing  or , To switch the display of the interface.







5.5. Settings menu interface

The setting menu is used for setting: Wire Type. Current sensor type and transformation ratio, voltage transformer transformation ratio, communication parameters, demand, backlight control, equipment time, password and other parameters.

Before enter the configuration page, you need to enter the configuration password (default 1000), By pressing OK Key Enter password, By pressing  or , Modify value size, and Long press  or  to switch displacement, (the corresponding value will flash), if the password is correct, pressing OK Key it will enter the configuration interface. If not, continue to stay in the password input interface.



If you forget the configuration password, you can enter the last four digits of the device serial number to enter the configuration interface

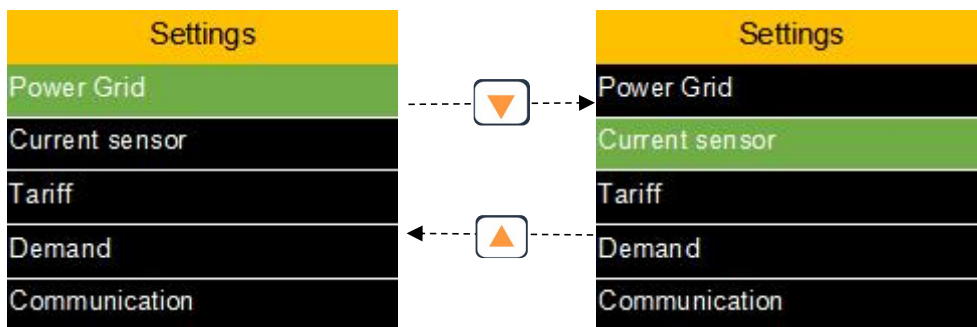

By pressing  or , To switch the display of the interface, By pressing OK Key, Enter parameter configuration.



5.5.1. Settings menu -Power Grid interface

Press the OK key to enter the power grid setting, press the  or  modify the value. After the data modification is completed, there will be a prompt on whether to save it. Press the OK key or the ESC key to select whether to save the modification.

The power grid sub-menu can set the Wire Type, Frequency, Nominal Voltage, VT ratio and CT ratio.

Wire Type:3P4W 4CT, 3P4W 3CT, 3P3W 3CT, 3P3W 2CT, 1P3W, 1P2W

Frequency: 50\60



Nominal Voltage:00001-65535

VT ratio:1~10000, (primary end voltage / secondary end voltage)*10000.Unit V/V

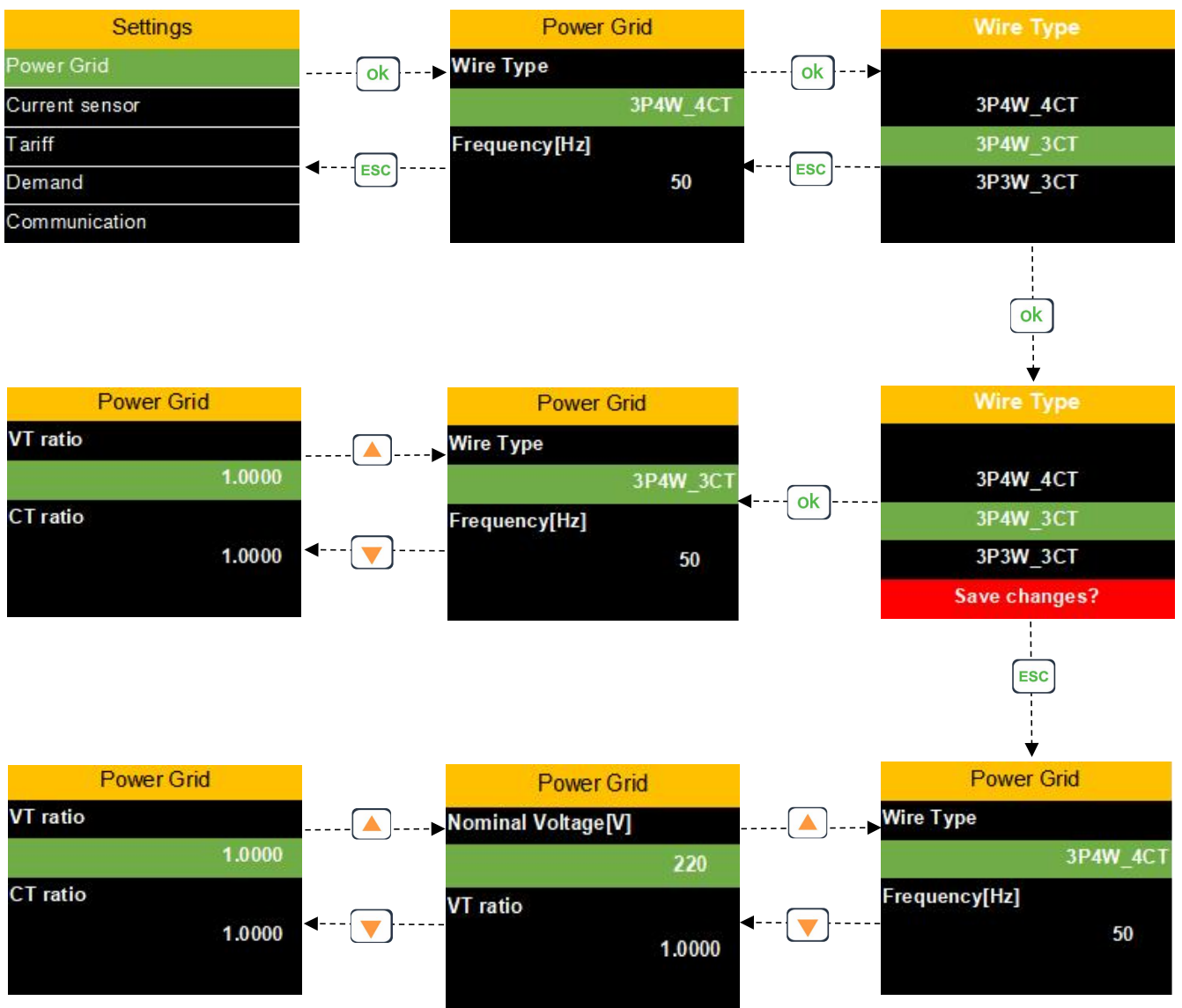
CT ratio:1~10000, (primary end current / secondary end current)*10000.Unit A/A



5.5.2. Settings menu -Current sensor interface

Press the OK key to enter the Current sensor setting, press the  or  modify the value. After the data modification is completed, there will be a prompt on whether to save it. Press the OK key or the ESC key to select whether to save the modification.

The Current sensor sub-menu can set Phase Type, Sensor Type, Pri[A], Sec[mV], Nominal Current[A].

Phase Type:I1,I2,I3 \ In

Sensor Type:Rcoil \ VCT

Pri[A]:1-999999



Sec[mV] (@50Hz/@60Hz) : 1-99999

Nominal Current [A]: 1-99999

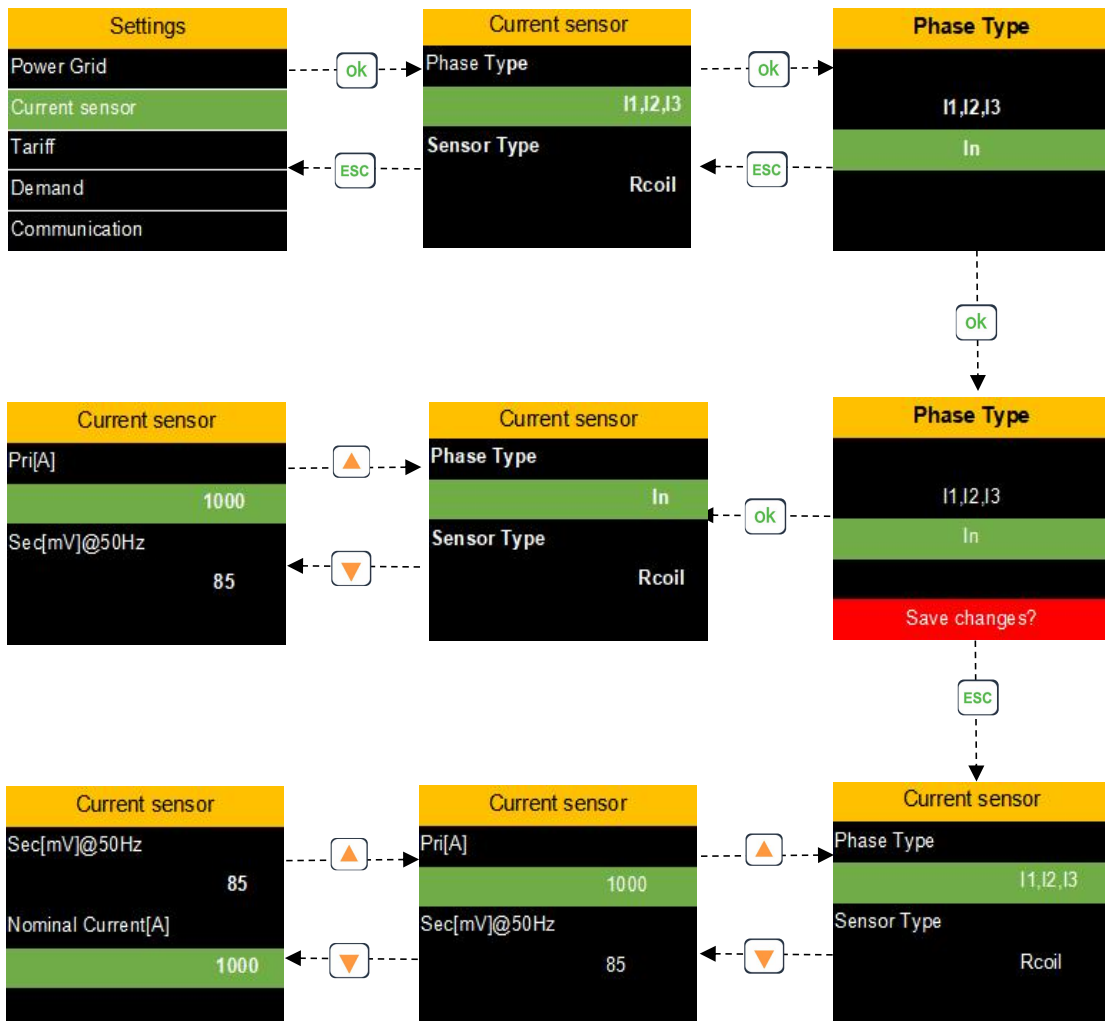
Parameter name	Explanation
Sensor type	Rcoil: Rogowski coil VCT: Voltage output type CT
Rcoil Pri	Rated primary current of Rogowski coil
Rcoil Sec	The secondary output value corresponding to the rated primary current
Nominal Current	The actual measured rated current value
For example,Coil Ratio:85mV/kA@50Hz, Rcoil Pri =1000A, Rcoil Sec=85mV, If measure 2000A, Nominal Current=2000A. If you want to measure 100A, change to keep 100 A nominal current. To replace the coil with different ratios, the Pri/Sec must be reset.	



5.5.3. Settings menu -Tariff interface

Press the OK key to enter the Tariff setting, press the  or  modify the value. After the data modification is completed, there will be a prompt on whether to save it. Press the OK key or the ESC key to select whether to save the modification.

The Tariff sub-menu can set Switch Mode, Start time, Tariff select.

Switch Mode: Manual\RTC

RTC Mode:



Can set Ta, Tb, Tc, Td, Te, Tf, 6 Start time and 6 Tariff select.

Manual Mode:

Can set Ta, Tb, Tc, Td, Te, Tf, 6 Tariff select.



5.5.4. Settings menu -Demand interface



Press the OK key to enter the Demand setting, press the  or  to modify the value. After the data modification is completed, there will be a prompt on whether to save it. Press the OK key or the ESC key to select whether to save the modification.

The Demand sub-menu can set Method, Block[minute]

Parameter name	Explanation
Calculation method	Fixed: update the demand according to the calculation interval Sliding type: update the demand once a minute
Calculation interval	Unit: minutes Range: 1-60 Default: 15 minutes



5.5.5. Settings menu -Communication interface

Press the OK key to enter the Communication setting, press the  or  modify the value. After the data modification is completed, there will be a prompt on whether to save it. Press the OK key or the ESC key to select whether to save the modification.

The Communication sub-menu can set Status, Device ID, Baud rate[bps], Parity, Stop bits.

Status: Enable \ Disable

Device ID: 000-247



Baud rate[bps]: 2400, 4800, 9600, 19200, 38400

Parity:None, Odd, Even

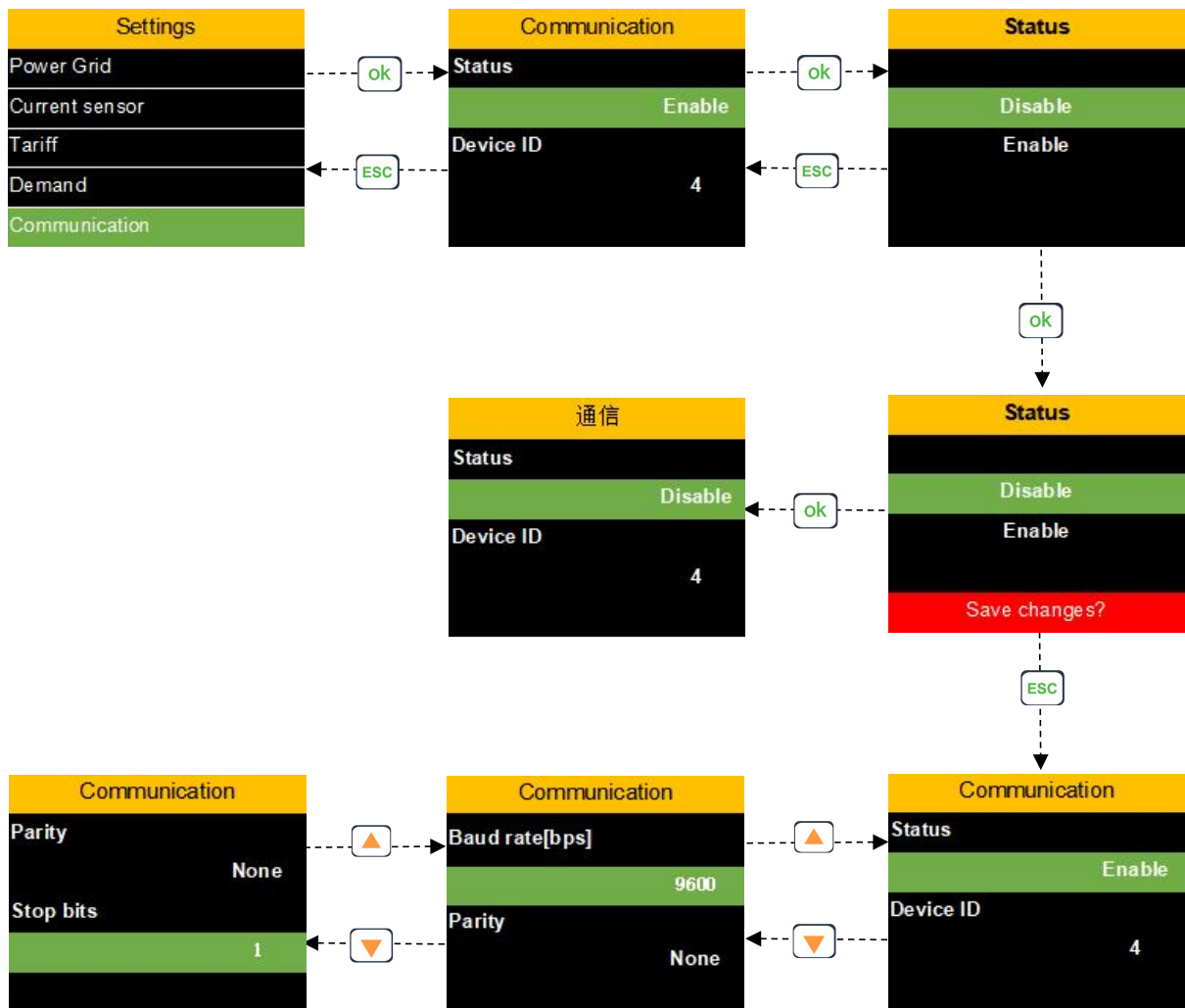
Stop bits:1 \ 2



5.5.6. Settings menu -HMI interface

Press the OK key to enter the HMI setting, press the  or  modify the value. After the data modification is completed, there will be a prompt on whether to save it. Press the OK key or the ESC key to select whether to save the modification.

The HMI sub-menu can set Language, Clock, Key Tone, Backlight OFF, Backlight Brightness.

Language: 中文 \ English

Clock: Year / month / day time: minutes: seconds





Key Tone: Enable \ Disable

Backlight OFF: Never \ 1 minute \ 2 minutes \ 3 minutes \ 4 minutes \ 5 minutes

Backlight Brightness: 1-5



5.5.7. Settings menu -Password interface

Press the OK key to enter the Password setting, press the  or  to modify value size, and Long press  or  to switch displacement(the corresponding value will flash). Then press the OK key or the ESC key to select whether to save the modification.

The Password sub-menu can set settings password, reset password.



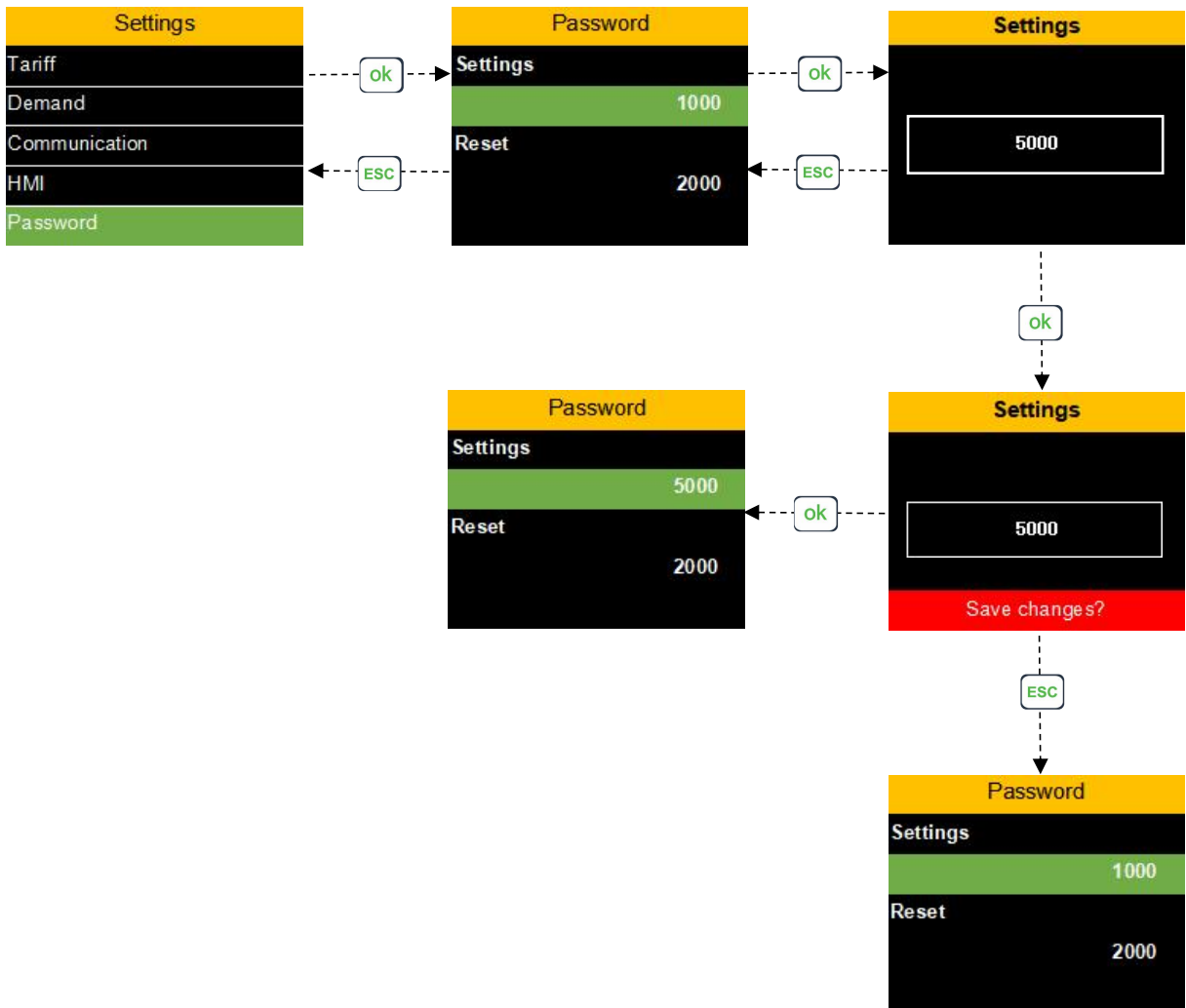

Settings password: 0001-9999

Reset password: 0001-9999





5.6. Reset menu interface

The reset menu is used for resetting Max.Min., Demand Max., Tariff Energy, Energy and Factory Set.

Before enter the configuration page, you need to enter the configuration password (default 2000), By pressing OK Key Enter password, By pressing  or , Modify value size, and Long press  or  to switch displacement, (the corresponding value will flash), if the password is correct, pressing OK Key it will enter the configuration interface. If not, continue to stay in the password input interface.

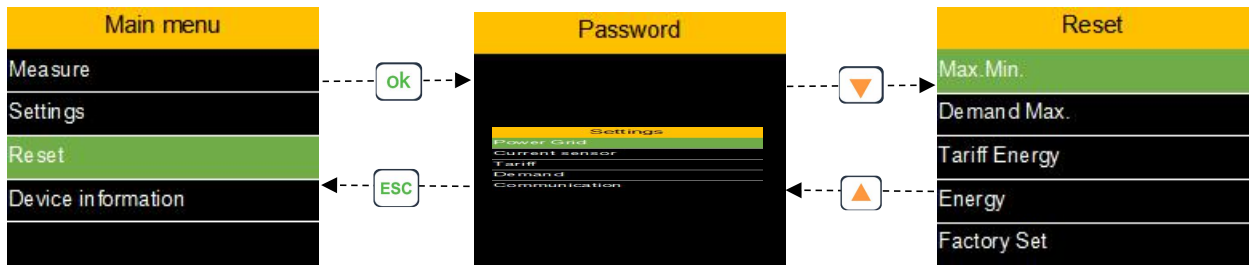
If you forget the configuration password, you can enter the last four digits of the device serial number to enter the configuration interface



By pressing  or , To switch the display of the interface, By pressing OK Key, Enter parameter configuration.

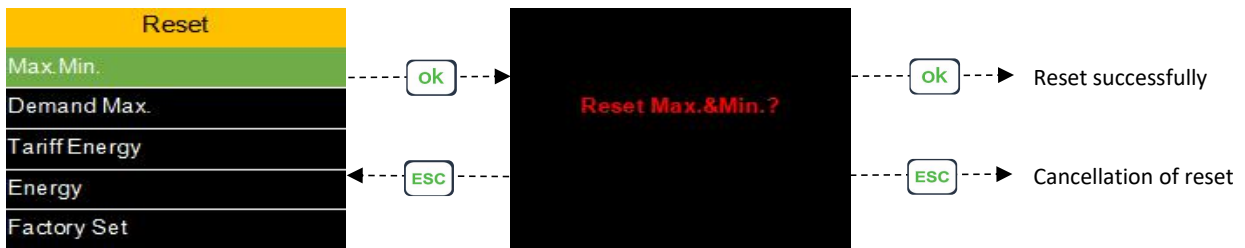

5.7. Device information menu interface

The device information menu is used to display: Device model, S/N, Firmware, Communication, Power grid parameters, and other data.

By pressing  or , To switch the display of the interface.

The Device information menu is shown in the figure below:

