



OPERATING INSTRUCTIONS

M-Sens 2

ONLINE MOISTURE MEASUREMENT FOR SOLIDS



For the 1st use of the sensor, correct sensor type should be selected via the screen or the software. Software must be installed if needed.

1. SOFTWARE INSTALLATION

If you want to communicate with our sensor using our dedicated software, you need to download the latest version on our website and install it.

→ <https://www.envea.global/solutions/process-optimization/dahs-software/>

It might also be necessary to install drivers, also available on our website.

2. MSE 300-FH (WITH SCREEN)

The display is touch-sensitive. Available keys are displayed directly in context. When the measuring system is first started, a query is initiated to select the language and sensor.

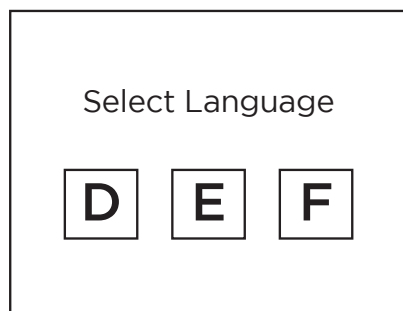

Initialization screen when the Evaluation unit in the field housing started first time.

Selection of the menu language: Deutsch, English, Français.

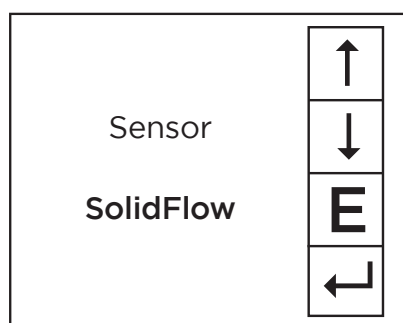

If a language has been selected, the sensor to be used must be selected. To be available:

SolidFlow 2.0, Paddy, PicoFlow, MaxxFlow HTC, DensFlow, SpeedFlow 2.0, SlideControl 2.0, ProSens, M-Sens 2, M-Sens 3, M-Sens WR, M-Sens WR2.

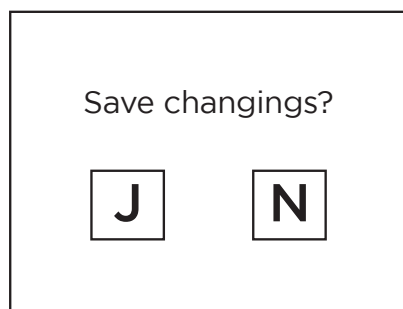

If any data has been changed, the change will only be taken into account when you exit the complete menu structure and answer [Yes] when asked if you wish to save the changes. Afterwards the start page appears.

3. MSE 300-DR / -DR2 (NO SCREEN)

Our dedicated software must be used to connect to the sensor Evaluation unit.

Select software language

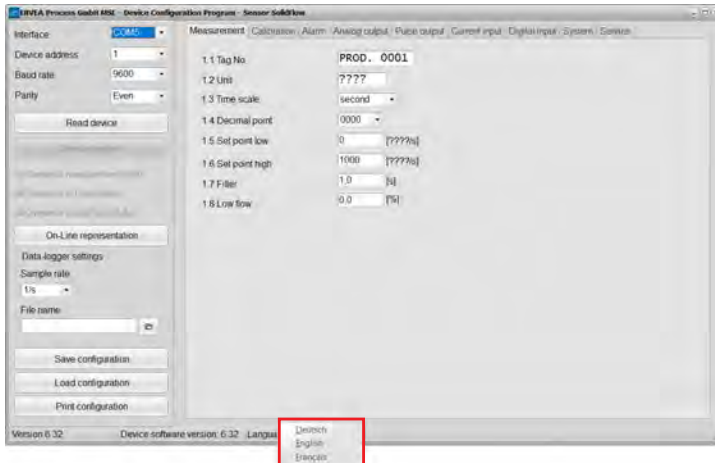

Right click on „Sprache/Language/ Langue“ and select desired language.

Connect to sensor

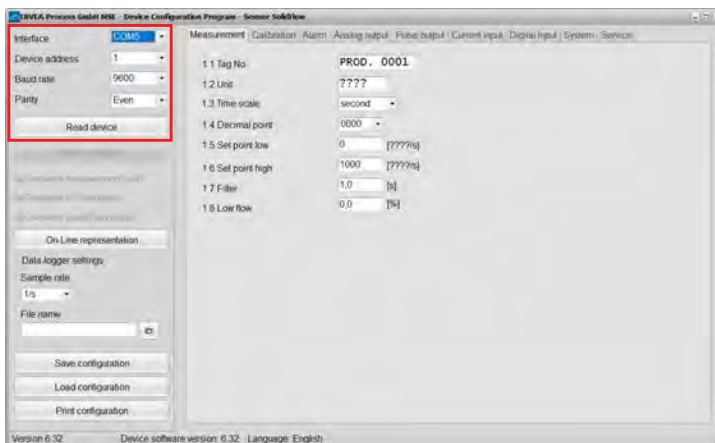

Select the correct COM port and connect to the device using the „read device“ button.

Select correct sensor

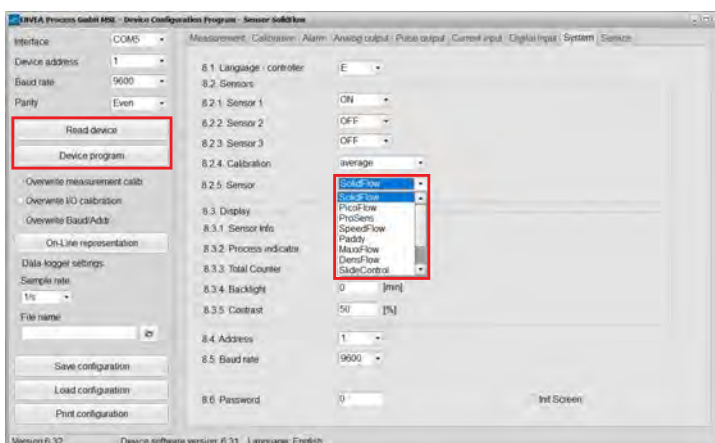

In the menu „System“, under „Sensor“ (8.2.5 or 7.2.5), the correct sensor must be selected.

After selecting the sensor, check the box „Overwrite measurement calib.“ and confirm with the button „Device program“.

For more informations and details, please refer to the user manual of the sensor.

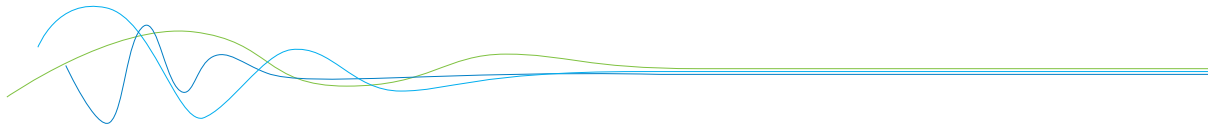

CONTENTS	Page
1. System overview	3
2. Function	5
3. Safety	6
3.1 Regular use	6
3.2 Identification of dangers	6
3.3 Operational safety	6
3.4 Technical progress	6
4. Mounting and installation	7
4.1 Delivery range	7
4.2 Auxiliary	7
4.3 Mounting of the sensor	7
4.4 Mounting of the Evaluation unit	11
4.5 Use in the explosion hazard area	13
5. Electrical connection	14
5.1 DIN Rail housing	14
5.2 Field housing terminal layout	15
5.3 Terminal layout C-Boxes	16
6. Commissioning	17
7. Menu structure of M-Sens 2	18
8. Operator interface	28
8.1 Differences between the DIN Rail and field housing Evaluation unit	28
8.2 Display	29
8.3 PC interface	31
9. Maintenance	33
10. Measurement precision	33
11. Warranty	34
12. Troubleshooting	34
13. Technical data	35

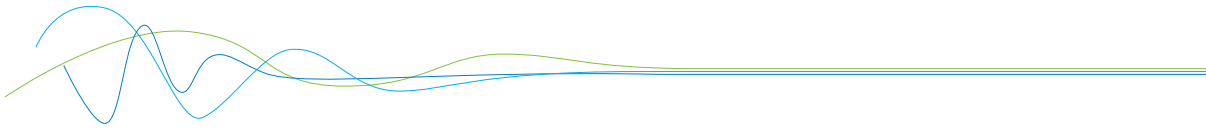

1. System overview

A complete M-Sens 2 unit consists of the following components:

- 1 welding flange per sensor
- 1 to 3 sensors with 2 m connecting cable
- Evaluation unit MSE 300 up to 3 sensors in a DIN Rail housing or a field housing
- C1-Box or C3-Box for connecting sensor(s) and Evaluation unit

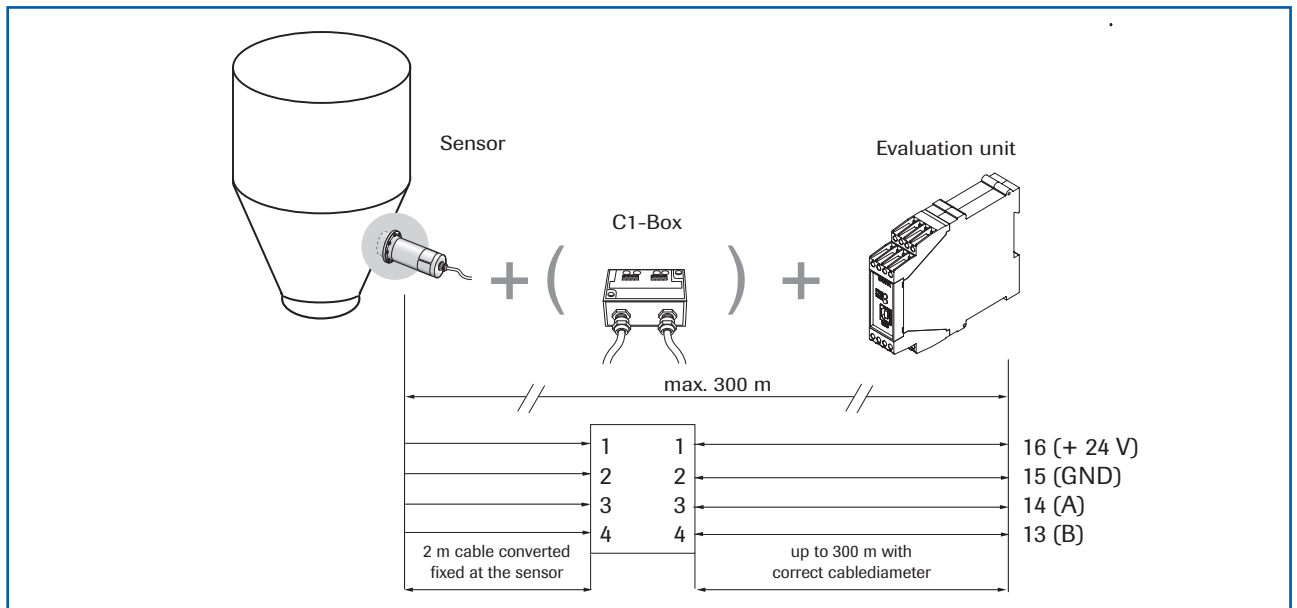

Fig. 1: Overview with C1-Box and DIN Rail Evaluation unit

The sensor is connected by a shielded, 4-wired cable to the Evaluation unit; the maximal distance between these devices can be at most 300 m.

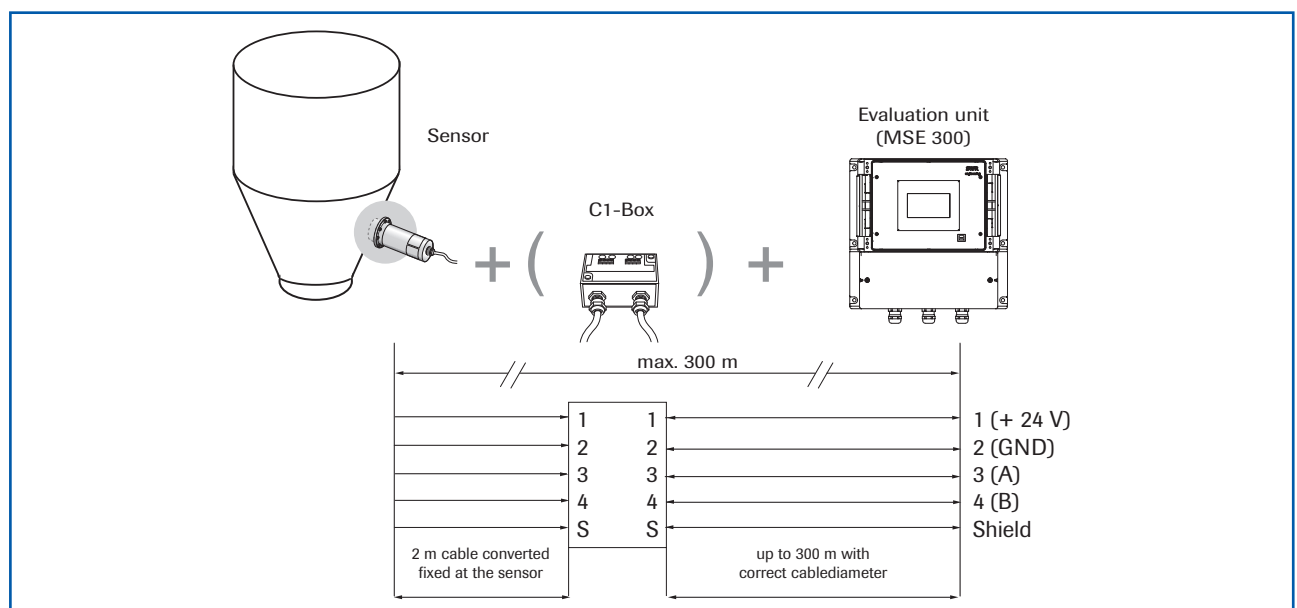
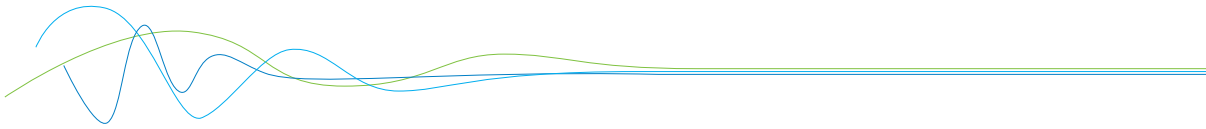

Fig. 2: Overview with C1-Box and field housing Evaluation unit



The system can be equipped with up to three sensors. Different C-Boxes (C1, C3) are used accordingly.

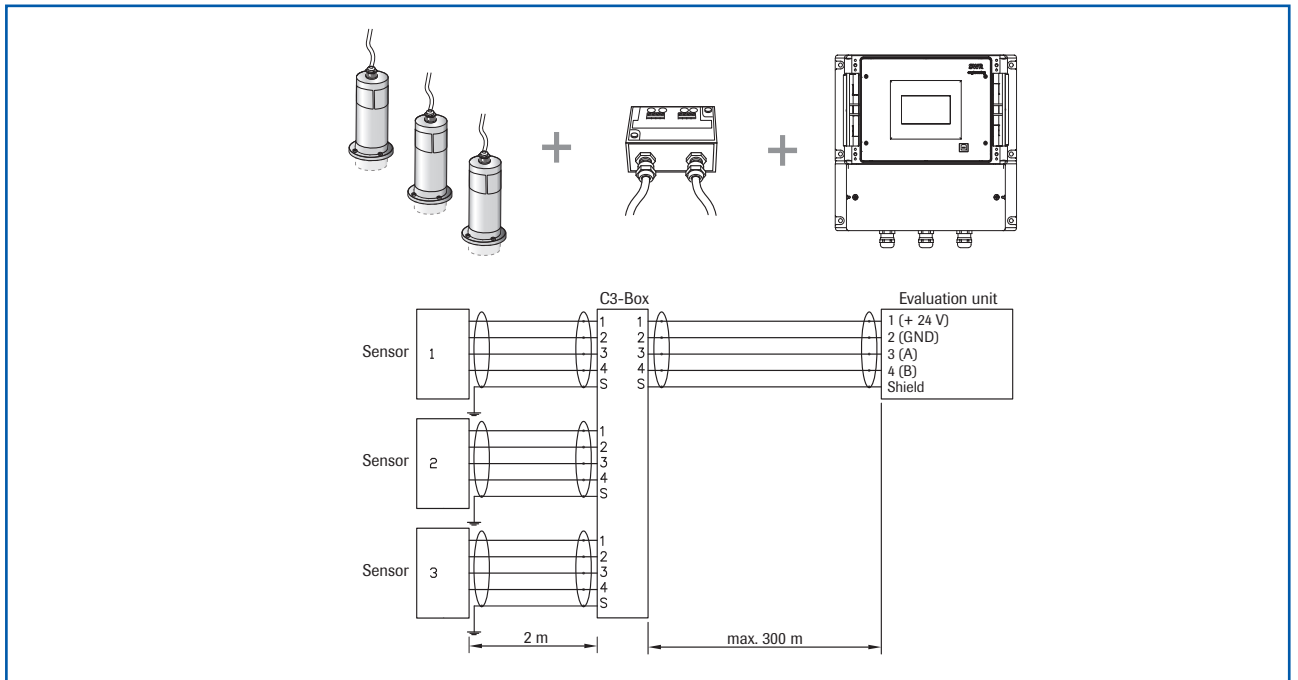

Fig. 3: Overview with C3-Box and field housing

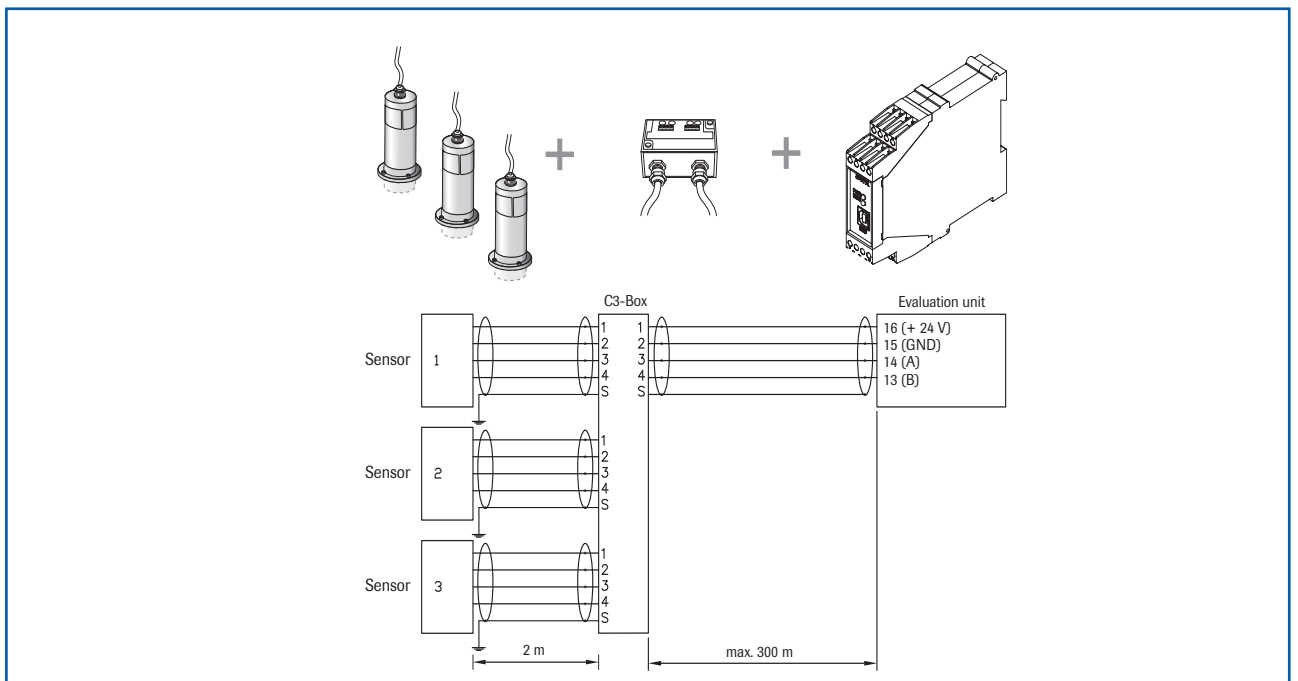
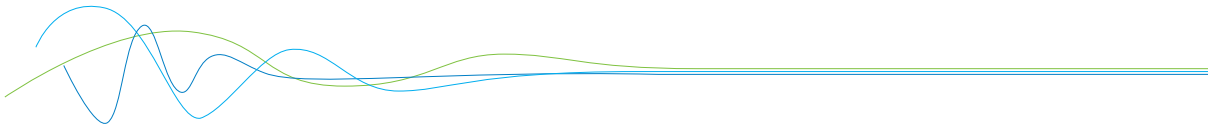

Fig. 4: Overview with C3-Box and DIN Rail Evaluation unit



2. Function

The M-Sens 2 sensor functionality is based on precise high-frequency measurement and direct digitalization of measured values, where from results a high resolution. As the material surface and capillary moisture influences strongly its specific conductive capacity, the moisture can be measured exactly by a constant averaged bulk density. By way of support, any fluctuations of the measuring value caused by the bulk density are balanced through an internal filter function. Temperature-related fluctuations of the measuring value are automatically compensated by the sensor. On the installed system, the calibration is a matter of pushing a button and entering the moisture reference value.

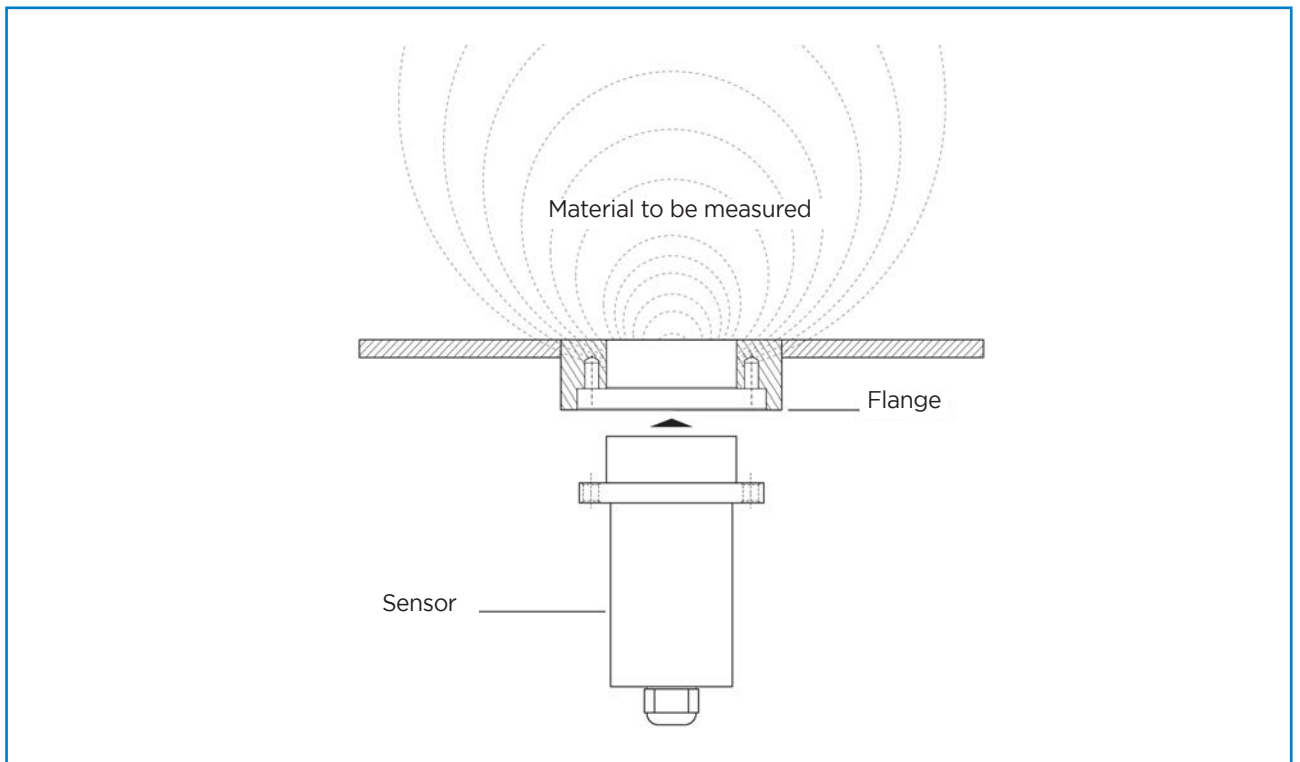

Fig. 5: Coupling and reflection of the high frequency

3. Safety

The measuring system M-Sens 2 designed and built according the latest technology has been tested to be safe and was shipped in safe condition. Nevertheless persons or objects may be endangered by components of the system if these are operated in an inexperienced manner.

The operating instructions must therefore be read in its entirety, and the safety instructions must be adhered to. If the device is used in a way that does not adhere to its intended and/or proper use, any liability or warranty on the part of the manufacturer is void.

3.1 Regular use

- Only original spare parts and accessories of ENVEA Process must be used.

3.2 Identification of dangers

- Possible dangers when using the measuring system are marked by the following symbols in the operating instructions:



Warning!

- This symbol in the operating instructions marks actions, which may represent a danger for life and limb of persons when carried out in an inexperienced manner.



Attention!

- All actions which may endanger objects are marked with this symbol in the operating instructions.

3.3 Operational safety

- The measuring system must be installed by trained and authorized personnel only.
- Switch of the power supply for all maintenance, cleaning or inspection works on the tubes or on components of the M-Sens 2. Follow the notes of the chapter maintenance.
- Sensor must be removed from the installation place before any welding work in the area.
- The components and electrical connections must be checked for damages regularly. If a damage is found, it is to be repaired before further operation of the instruments.

3.4 Technical progress

- ENVEA Process reserves the right to adapt technical data to the technical progress without particular advance notice. If you have any questions, ENVEA Process will be pleased to inform you on possible changes and extensions of the operating instructions.

4. Mounting and installation

4.1 Delivery range

- Evaluation unit in DIN Rail housing or field housing
- Sensor
- Operating instructions
- C1-Box or C3-Box
- Welding flange

4.2 Auxiliary

- Screw driver 2.5 mm
- Allen key 5 mm

4.3 Mounting of the sensor

M-Sens 2 is designed for continuous moisture measurement. Most important conditions for correct measurement is the right choice of the mounting place of the sensor. That is, when using chutes or conveyor belts, it is very important to have a almost even material height in front of the sensor window.

- The flange is welded without sensor and dummy plate in the opening at determined mounting place. Sensor and dummy plate are mounting by means of plumbing lubricant. For applications without over-pressure it is possible to renounce the 2 sealing rings.



Attention!

The flange mustn't be welded together with the sensor or dummy plate (incl. the sealing rings).

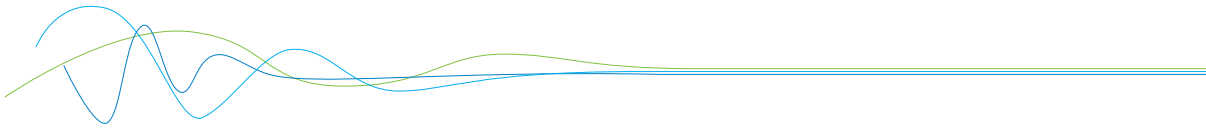

APPLICATIONS - PRACTICAL EXAMPLES

- **Installation in a screw**

The installation of a moisture sensor in screw feeders proved to be very advantageous, since the material passes by the sensor window in even intervals and with relatively constant bulk density.

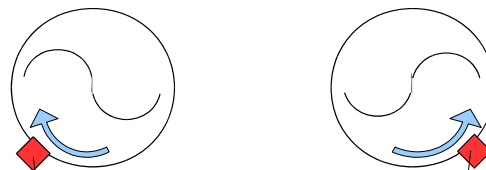
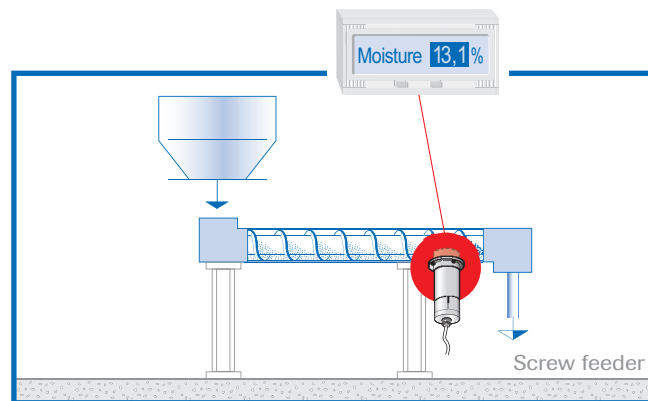

Do not install the sensor under or on the side of the screw, it must be installed mid-size from bottom, on the side where material is pushed up (depending rotation side of the screw). (Approximattly 30° from the screw bottom).

- **Installation on a conveyor belt**

By means of the online moisture measurement of solids on a conveyor belt, the operator can react in due time if the material is too humid or too dry. In consequence, plugging of subsequent aggregates can be prevented.

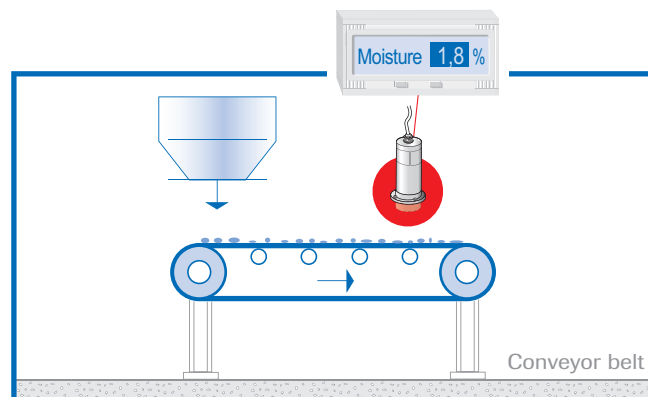

- **Installation in a bin**

Another installation alternative is to mount a sensor at a bins outlet. Due to constant bulk density in case of a filled bin, the sensor finds an almost unchanging measuring field for monitoring the residual moisture. Thus, M-Sens 2 avoids that material with too high or too low moisture reaches the next production level or arrives into the loading.

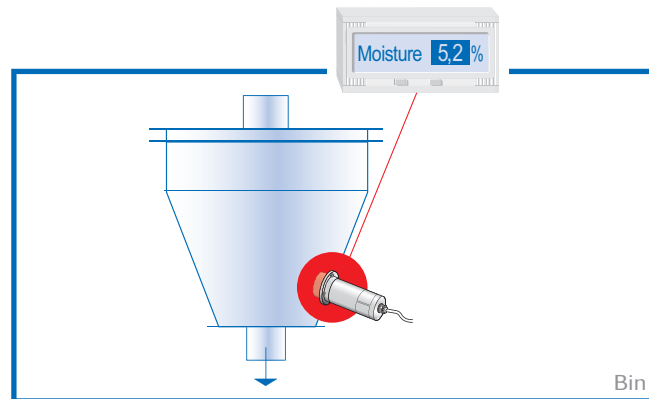

- **Control of dryer by means of moisture measurement**

After the material, lying on the belt, has passed through the dryer tunnel, it gets with drawn from the hot air zone. At the end of the belt the dried material falls in a screw conveyor which transports it to the processing.

The operator queries the following points: Has the material reached really the desired residual moisture value? That is, has he chosen the right cycle time and temperature?

M-Sens 2 provides accurate and reliable online moisture values for the process control, by which constant moisture in close tolerances of the output material can be met.

This process optimization enables the operator to manage high savings and quality improvements.

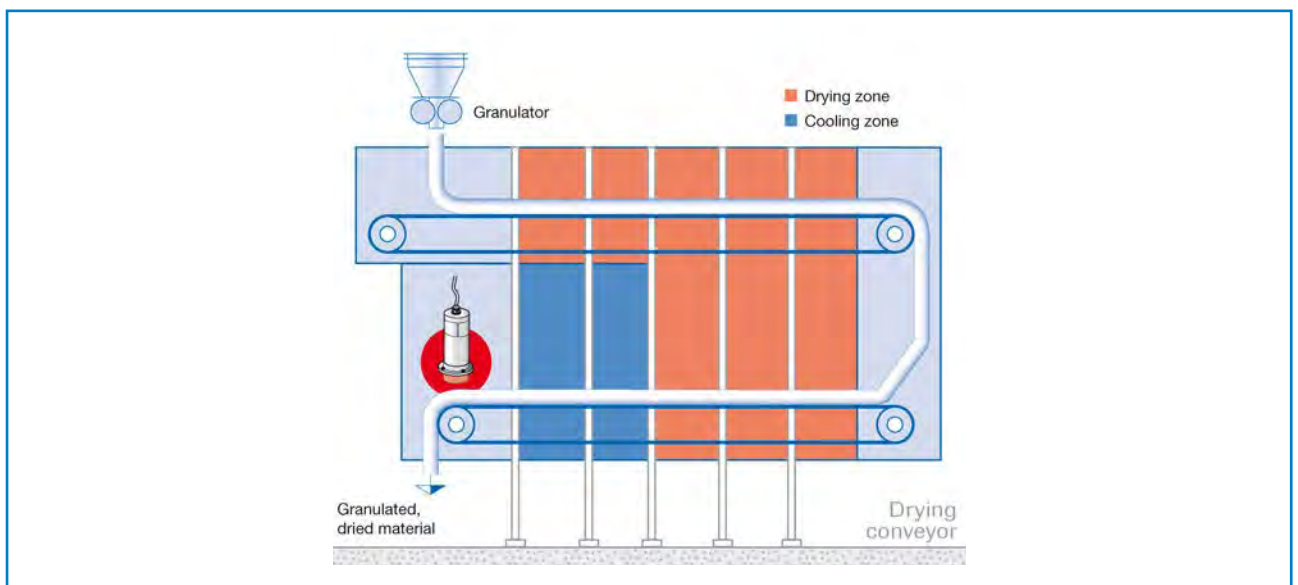

- **Moisture measurement in a mixer**

M-Sens 2 can be installed, even later on, in all types of mixers. The measuring values logging is done by within the moving material during the mixer procedure.

With the measured moisture value of the material in the dryer process parameters like detention time and dosage quantity can be controlled.

For this purpose M-Sens 2 is connected to a PLC or another process control system.



Mixer

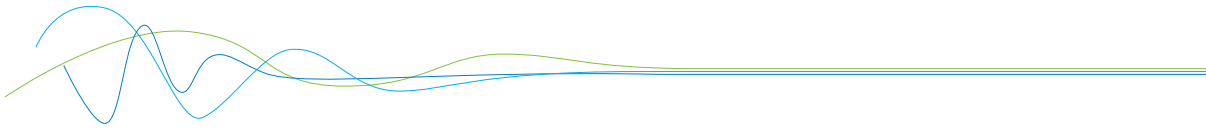

4.4 Mounting of the Evaluation unit

The Evaluation unit can be installed at a maximum distance of 300 m from the sensor. A cable of type “Ölflex Classic 110 CY” is recommended. The cable should be four wired, twisted and shielded. A minimum cable cross-section of 0.75 mm² should be observed. For distances more than 150 m the cable cross-section should be adjusted.

The housing is prepared for DIN Rail mounting according to DIN EN 60715 TH35.

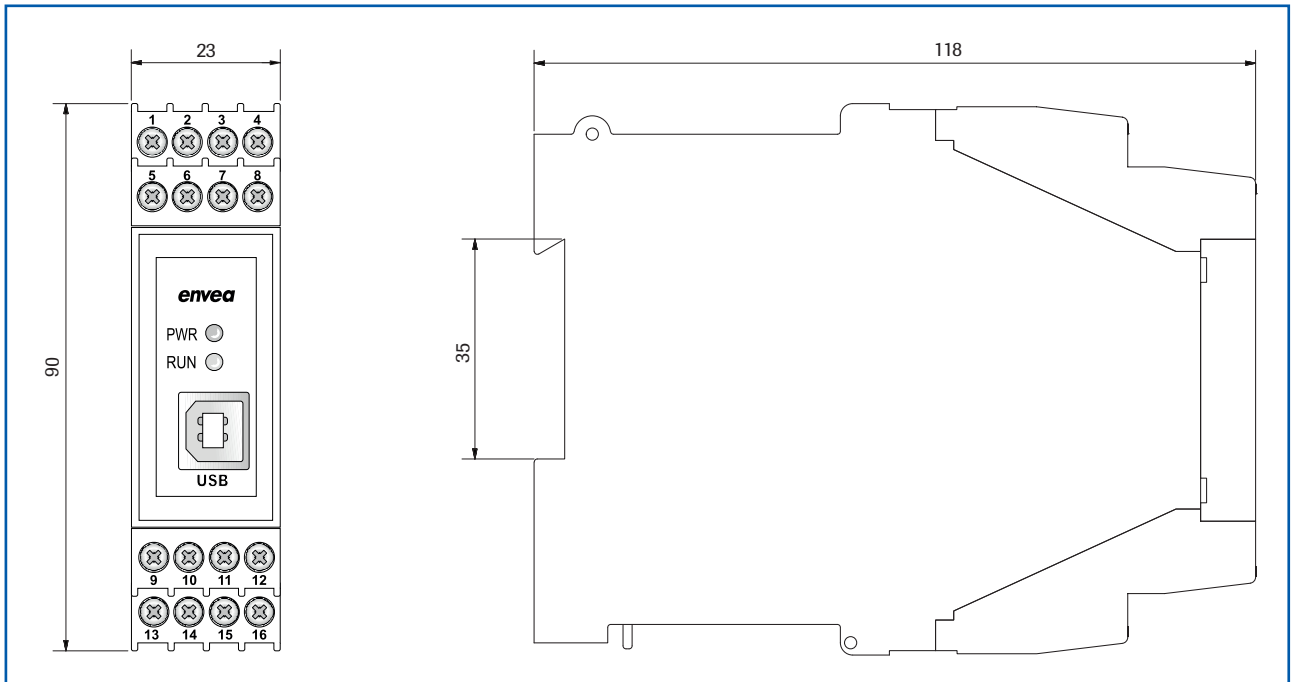

Fig. 12: Dimension of Evaluation unit in DIN Rail housing

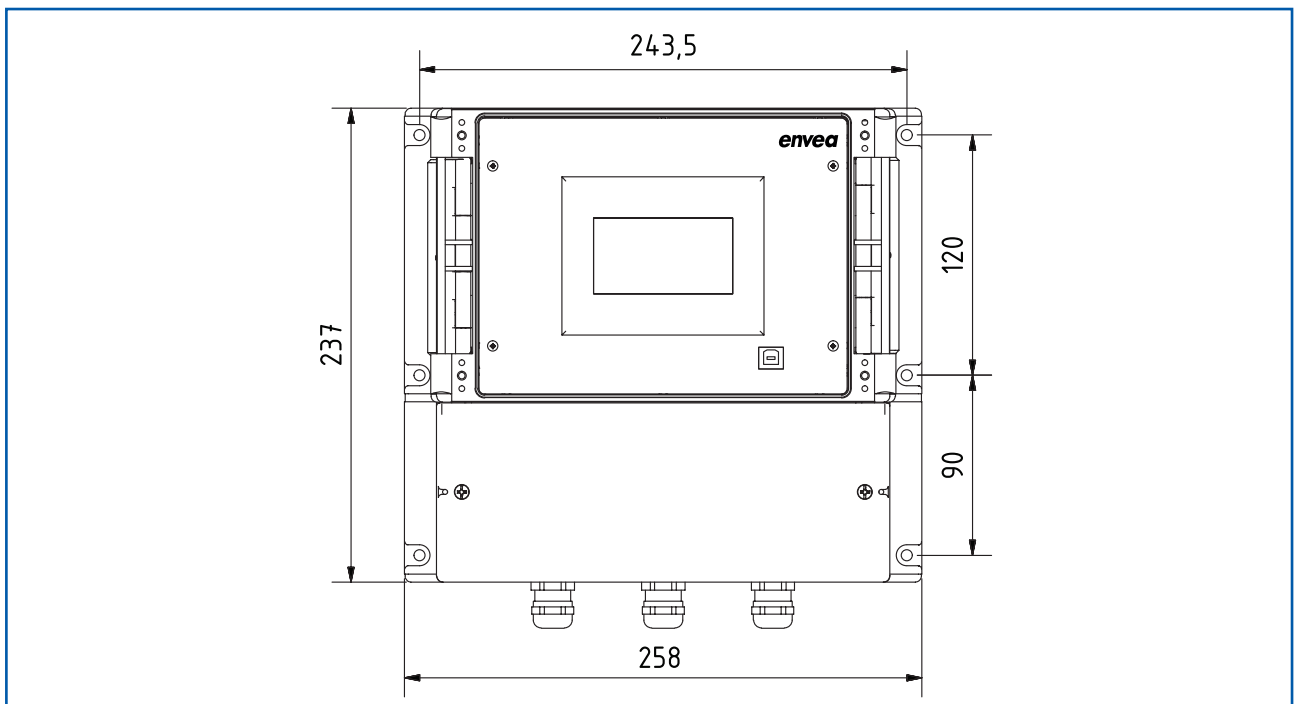

Fig. 13: Dimension of Evaluation unit in field housing (front view)

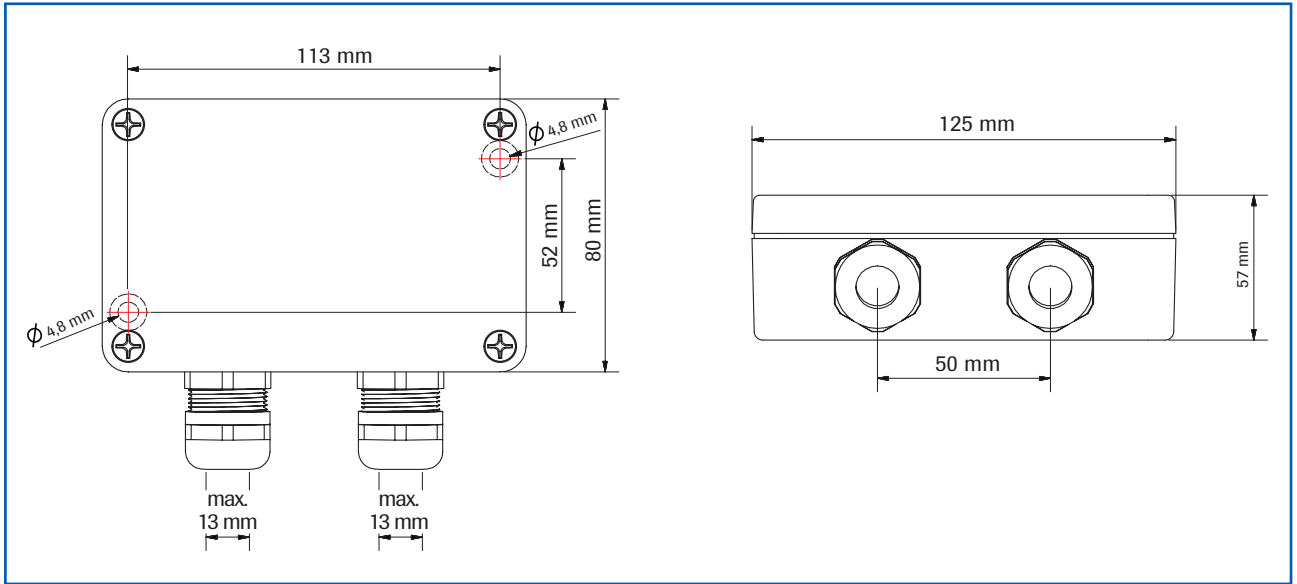
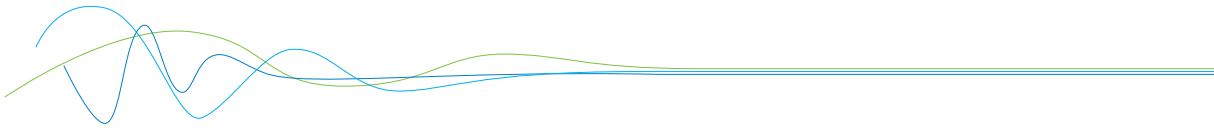

Fig. 14: Field housing for the C1-Box

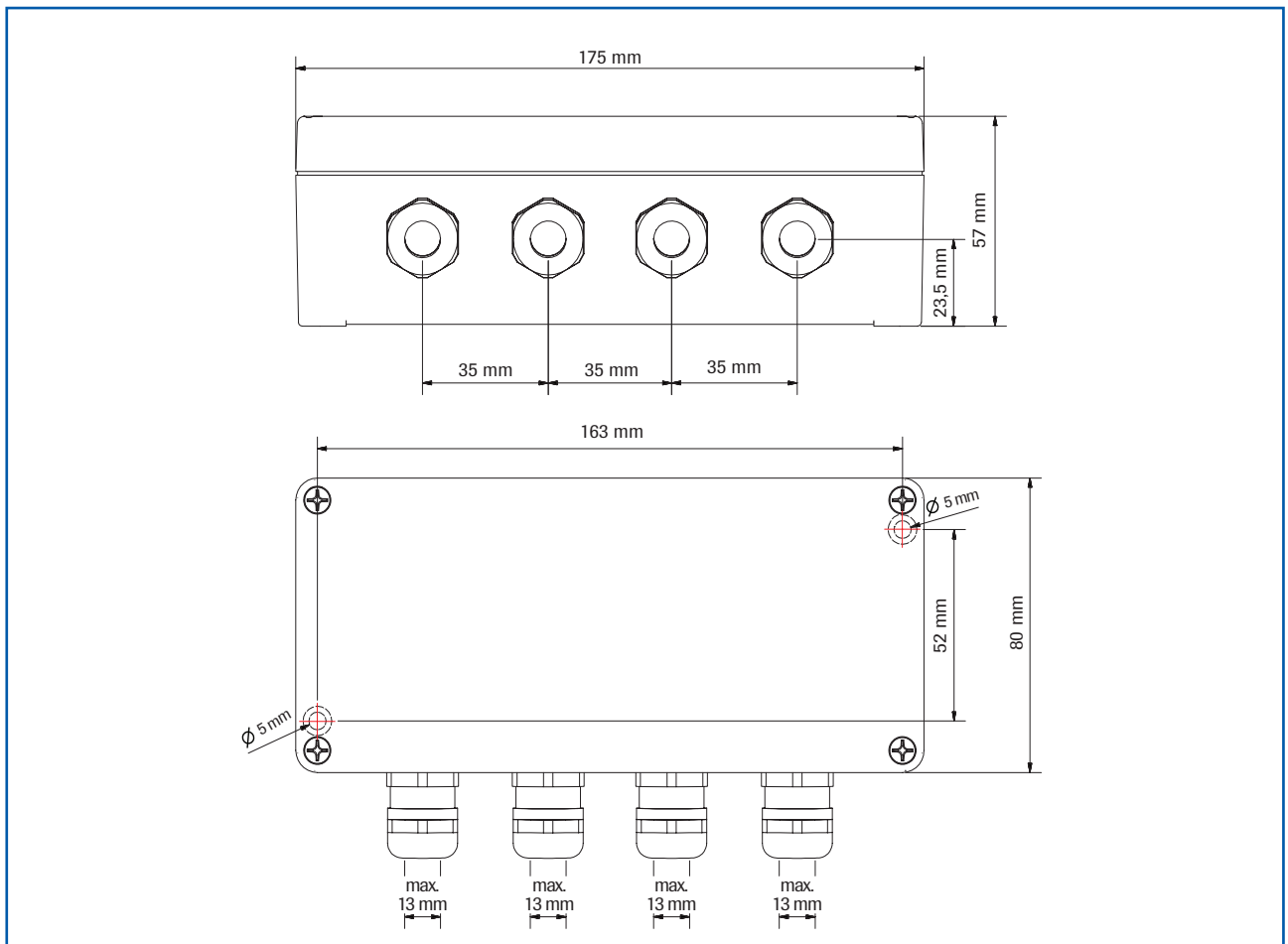

Fig. 15: Field housing for the C3-Box

The C1-Box and C3-Box contain fuses and resistances in order to guarantee the communication by the ModBus between sensor and Evaluation unit.

4.5 Use in the explosion hazard area

DustEx labelling:  II 1D Ex maD iaD 20 T120 °C

- Group of equipment 2
- Equipment category: 1
- Zone 20
- For explosive mixtures of air and flammable dust
- Permissible process temperature 0 ... 80 °C
- Maximum surface temperature 120 °C with Ta = 80 °C

GasEx labelling:  II 1G Ex ma ia IIC T4

- Group of equipment 2
- Equipment category: 1
- Zone 0
- For explosive mixtures of air and flammable gases
- Permissible process temperature 0 ... 80 °C
- Maximum surface temperature T4 with Ta = 80 °C



Warning!

- The sensor has to be integrated into the equipotential bonding.
- Screws, especially grounding screw, must be tightened with a recommended torque of 8 to 10 Nm.
- The grounding cable must have a cross section of at least 4 mm².

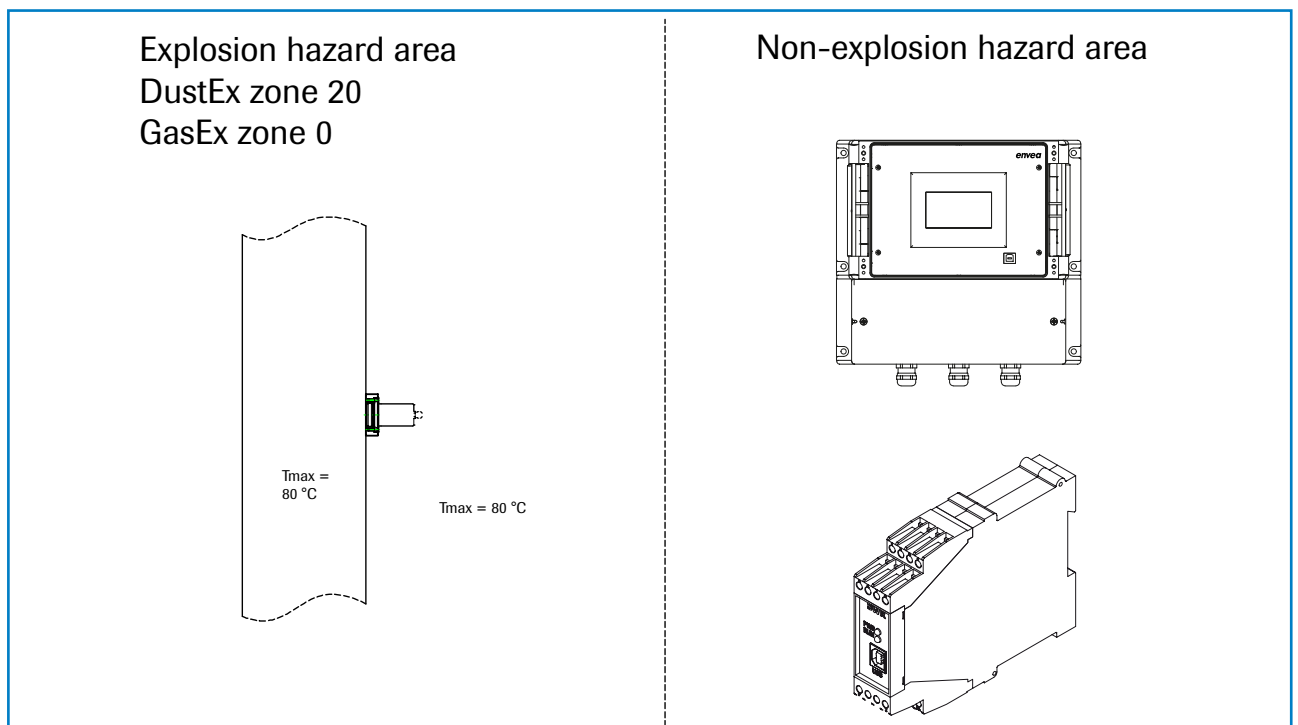

4.5.1 Ex protection type

The electronics of the M-Sens 2 sensor are designed to be intrinsically safe with respect to the rod probe. The separation between the intrinsically safe circuit at the rod probe and other parts of the electronics, protected by encapsulation “m”, takes place within the housing. With this setup, cabling with intrinsically safe circuits, blue sheathed cables, and blue fittings are not required.

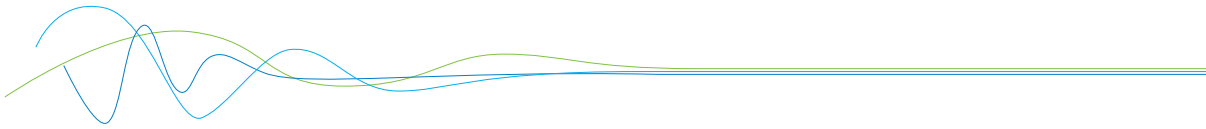

5. Electrical connection

5.1 DIN Rail housing

1 Current output - 4 ... 20 mA	2 Current output + 4 ... 20 mA	3 Input Power supply 0 V DC	4 Input Power supply + 24 V DC
5 Not used	6 Alarm relay NC (break contact)	7 Alarm relay C	8 Alarm relay NO (make contact)

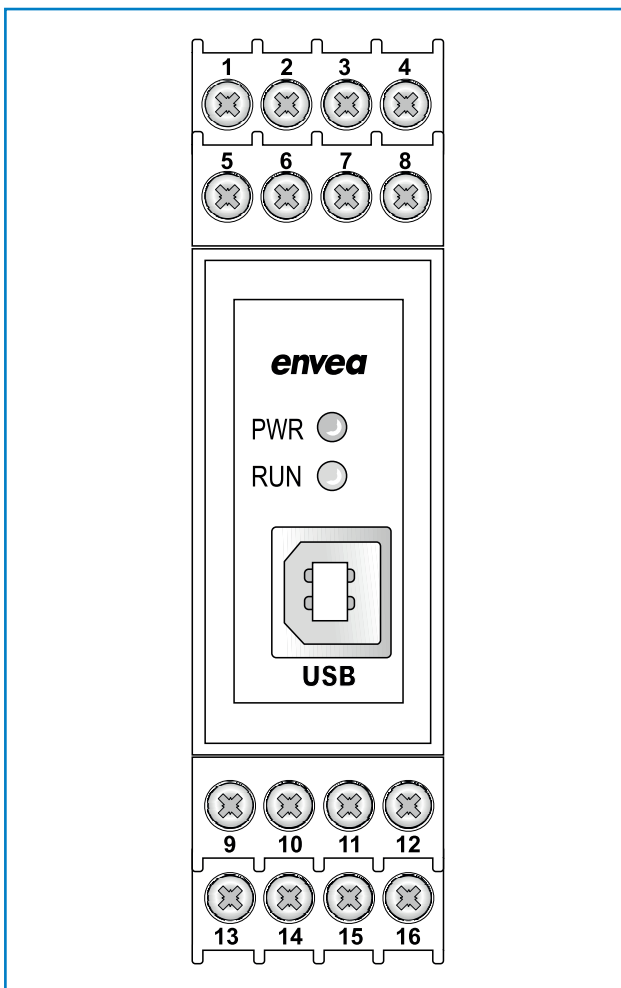

Fig. 17: Electrical connection of the Evaluation unit

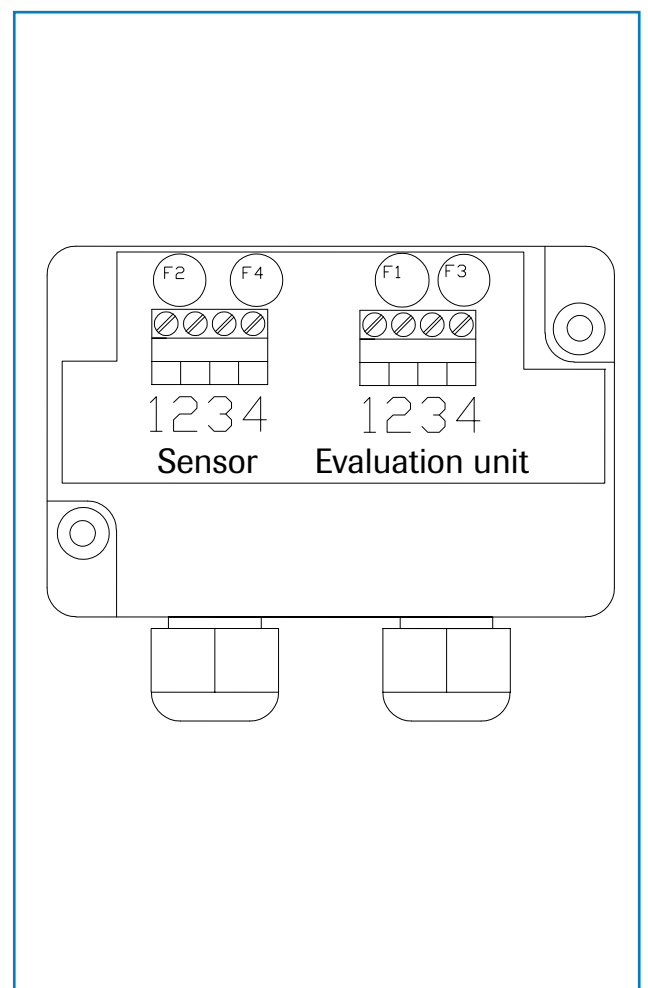
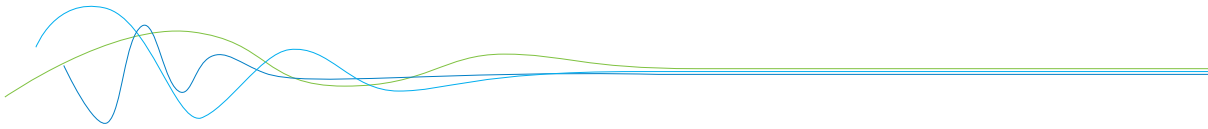

Fig. 18: Electrical connection of the C1-box

9 Digital pulse output (-)	10 Digital pulse output (+)	11 RS 485 Interface Data B	12 RS 485 Interface Data A
13 Sensor connection Cable 4 RS 485 Data B	14 Sensor connection Cable 3 RS 485 Data A	15 Sensor connection Cable 2 Power supply 0 V	16 Sensor connection Cable 1 Power supply + 24 V



5.2 Field housing terminal layout

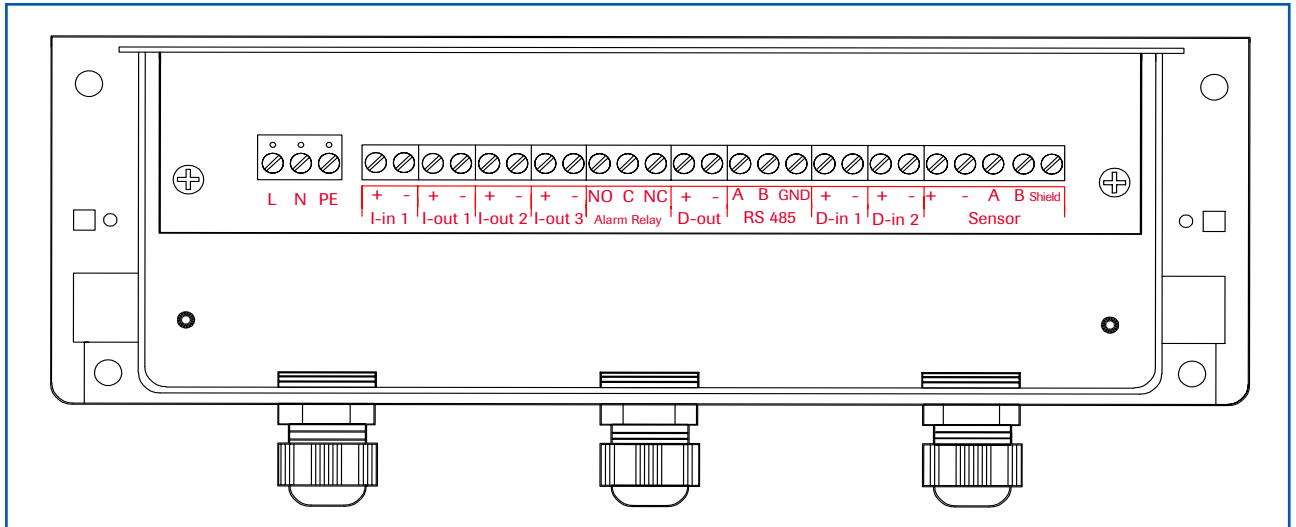

Fig. 19: Electrical connection

Evaluation unit			
Terminal No.	Connection		
Power supply connection			
L / +24 V	Input power supply 230 V / 50 Hz, 110 V / 60 Hz (optional 24 V DC)		
N / 0 V	Input power supply 230 V / 50 Hz, 110 V / 60 Hz (optional 24 V DC)		
PE	Earth		
Connections			
I-in1	+	Current input +	
	-	Current input -	
I-out1	+	Current output +	
	-	Current output -	
	Na	Not used	
	Na	Not used	
	Na	Not used	
	Na	Not used	
Min. / Max.- Relay	NO	Floating change-over contact NO (make contact)	
	C	Floating change-over contact C (common conductor)	
	NC	Floating change-over contact NC (break contact)	
D-out	+	Digital pulse output +	
	-	Digital pulse output -	
RS 485	A	RS 485 interface data A	
	B	RS 485 interface data B	
	GND	RS 485 interface ground	
D-in1	+	Digital interface 1 (+)	
	-	Digital interface 1 (-)	
D-in2	+	Digital interface 2 (+)	
	-	Digital interface 2 (-)	
Sensor	+	Power supply + 24 V	Cable no. 1
	GND	Power supply 0 V	Cable no. 2
	A	RS 485 data A	Cable no. 3
	B	RS 485 data B	Cable no. 4
	Shield	Shield	

5.3 Terminal layout C-Boxes

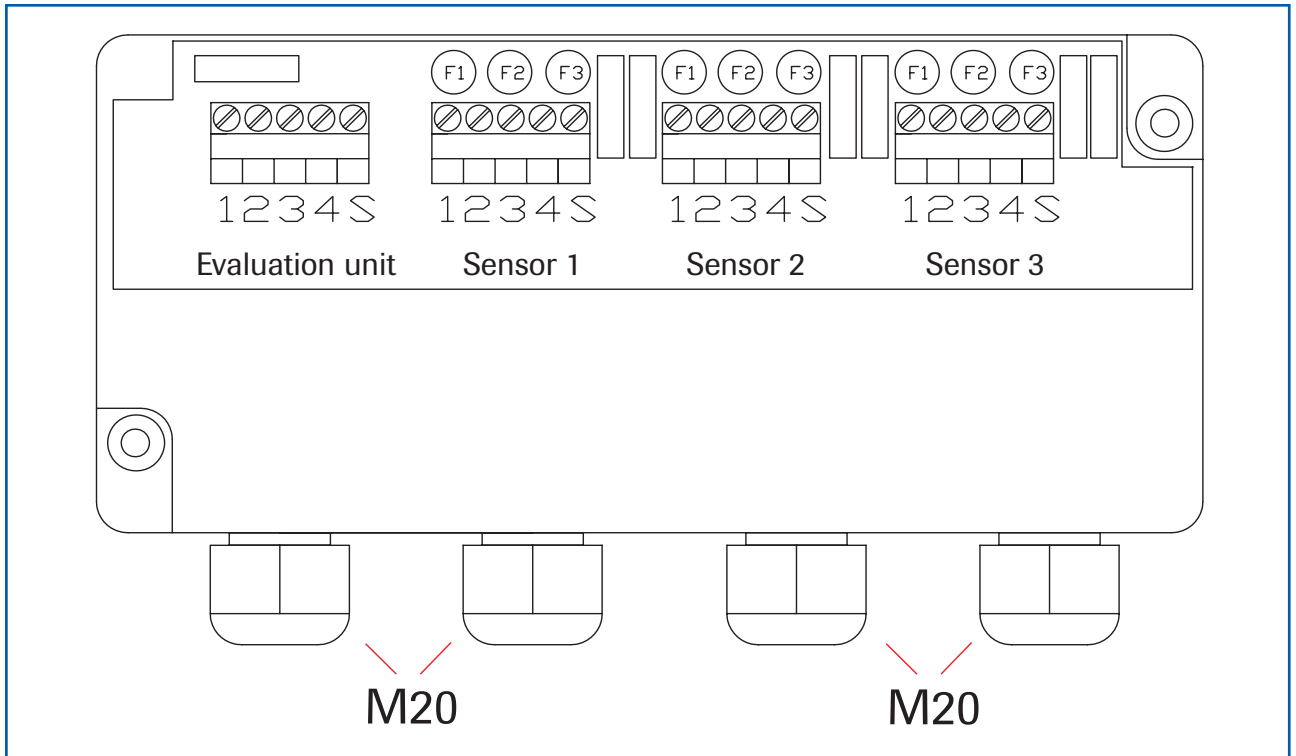

Fig. 20: Electrical connection for the C3-Box

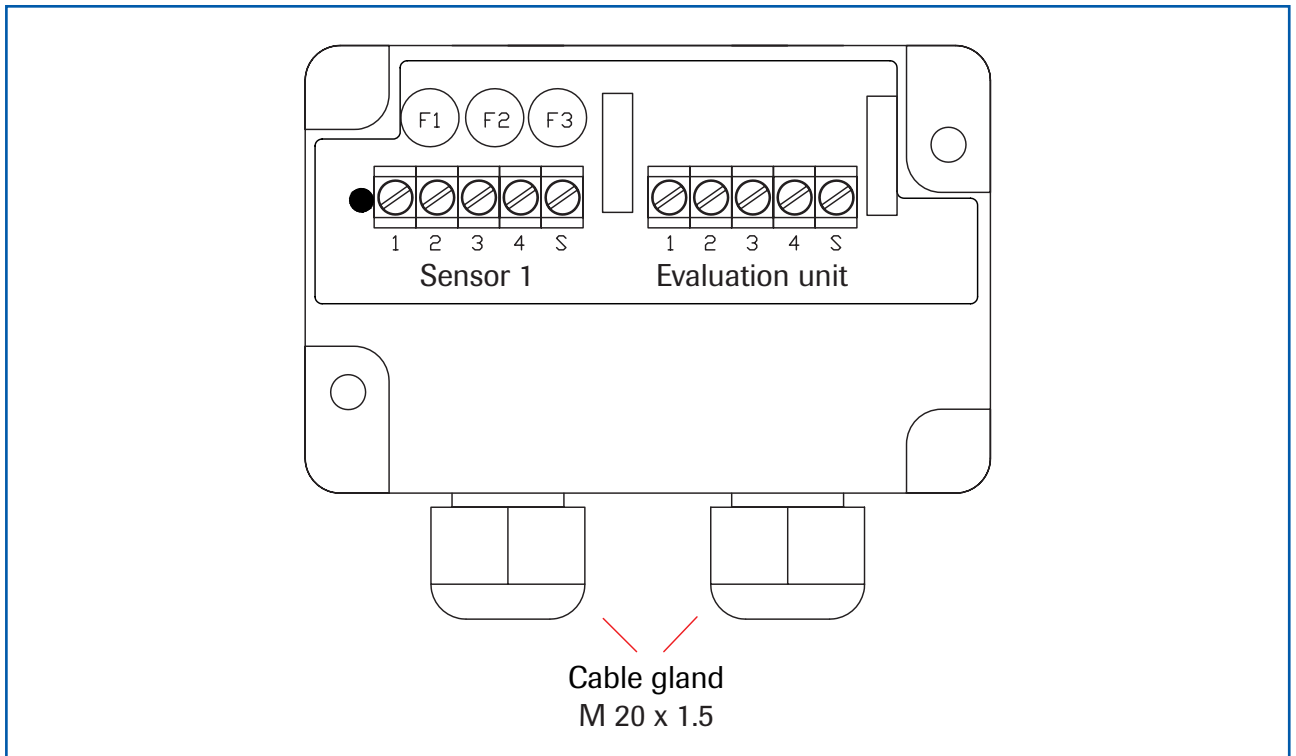
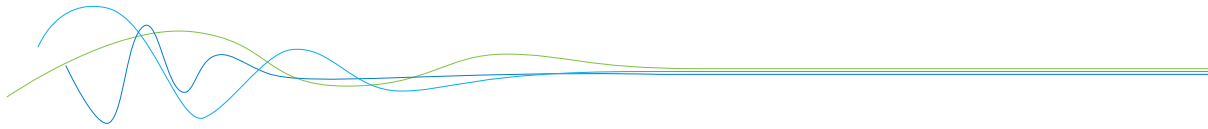

Fig. 21: Electrical connection for the C1-Box



6. Commissioning

At the first commissioning of the M-Sens 2 it is necessary to calibrate the sensor.

Please consider:

- Correct connection between sensor, C1-box and Evaluation unit.
- Correct installation of the sensor in the process.

In case of negative results in spite of consideration of the points as stated above, please contact ENVEA Process.

Commissioning of the M-Sens 2

After the delivery the sensor is **not calibrated to the product(s)**, so each calibration and parameterization has to be executed during the commissioning. Therefore it is necessary to assign the measured moisture to the desired display and to the initial value. The menu functions are very self-explanatory. In the following a short introduction to the menu overview:

Menu are accessible via PC software or the touch screen (fieldhousing unit only) – See Operator Interface.

Basic function	For the measurement using the sensor, at least 2 measuring points should be calibrated as a reference point and the corresponding moisture value should be entered. To do this, the reference point measurement is started in the calibration. After the measurement, the analysis device expects the input of the moisture content determined in the lab. While the material is conveyed (in the loading state), the 2nd point is set to a known moisture value and the calibration is also carried out. If only one material moisture value is available, then minor moisture fluctuations and corresponding fluctuations in the moisture values determined in the lab can be used to save at least 2 calibration points.
Adjustment	For the adjustment of user requirements with regard to material, measuring units etc.
Alarms	The user can select operation modes “None”, “Min”, “Max” in the menu Alarms (3.1). A shortfall or exceeding of an adjustable measuring value can be output via the alarm relay as “open” or “close” (3.5). In menu Sensor Alarm (3.6), the user can select “OFF” “ERR” or “Proc”. By choosing “ERR”, alarm will be on in case of sensor error, by selecting “PROC”, alarm will be on in case of fatal sensor errors/failure and process indicators.
Analog output	is modified in menu 4 and can be adjusted to user requirements here (e. g. 0... 20 mA). The setting of the minimum and maximum output current can be setup on 4.1 and 4.2. The alarm value can be defined on 4.3 and alarm type on 4.4. The exact calibration of the 4 mA and 20 mA value are done via menu 4.5 and 4.6 and 4.7. This operation require the use of a calibrated multimeter. The measuring range filter makes it possible to adapt to slower recording devices or continuous output at the analogue output (power output).
Calibration points	The measurement can be checked for linearity based on varying moisture values. To improve accuracy, these should be determined respectively. In case of deviations, the non-linearity can be corrected through a table of support points. Based on the points that are selected and specified in menus 2.4.1 etc. (a minimum of 2 during first commissioning), a correction value can now be entered for the actual moisture value. (This value can be changed later.) A maximum of 5 support points are available.
Saving changes	After changes are made, they can be saved using the menu item program device. The change is carried out once Overwrite calibration is confirmed.
C1-Box	Is only used when the distance between sensor and analysis unit exceeds 2 m.
C3-Box	Is only used when 2 or 3 sensors are connected.

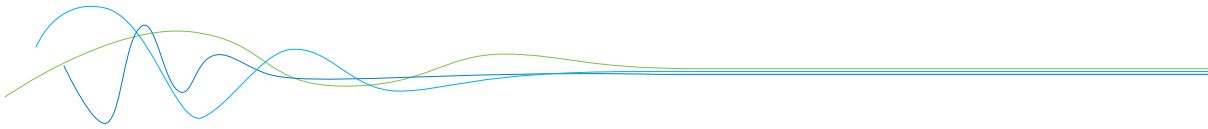

7. Menu structure of M-Sens 2

This software is available for download on our website:

<https://www.envea.global/solutions/process-optimization/dahs-software/>

The menu structure supports the user when adjusting the measuring range, the calibration, the measurement values and the choice of additional functions. In this connection, the numbering both on the display and in the PC interface is identical:

1. Measuring range

Set all relevant measuring range settings

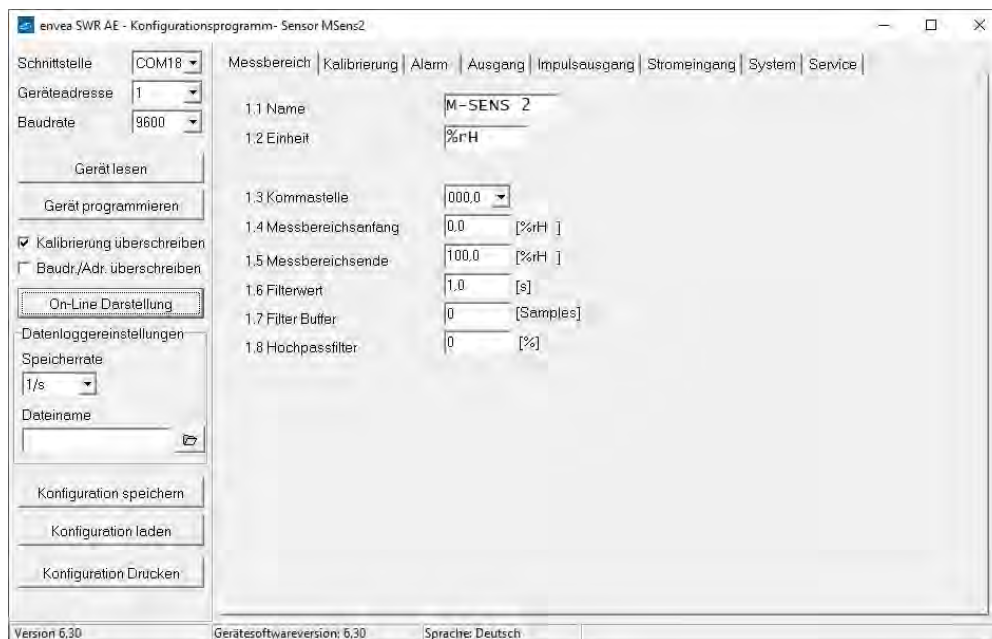

1.1 Tag No.	Input: free text (10 characters)	Name of the measurement point or product.
1.2 Unit	Input: unit text, e. g. kg	Required mass flow unit.
1.3 Decimal point	Selection: 0000, 0.000, 00.00, 000.0	Number representation and decimal point-accuracy in the measurement menu.
1.4 Set point low	Input: 0 ... 9999	Throughput rates under this value will not be displayed at the current output. This does not concern the display indicator, totaliser or pulse output (= 4mA).
1.5 Set point high	Input: 0 ... 9999	Throughput rates above this value will not be displayed at the current output. This does not concern the display indicator, totaliser or pulse output (= 20mA).
1.6 Filter	Input: 0.1 s ... 99.9 s	Filtering of measurement for the indicator and the output values.
1.7 Filter buffer	Input: 0.0 ...	
1.8 High pass filter	Input: 0 ... 100	

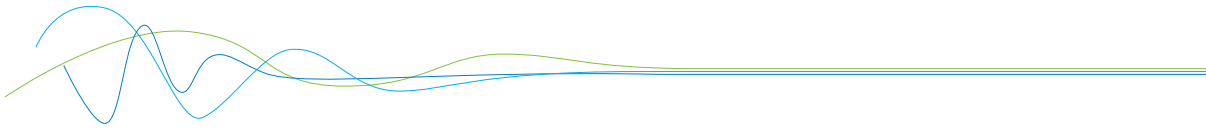

2. Calibration

Store the calibration curve.

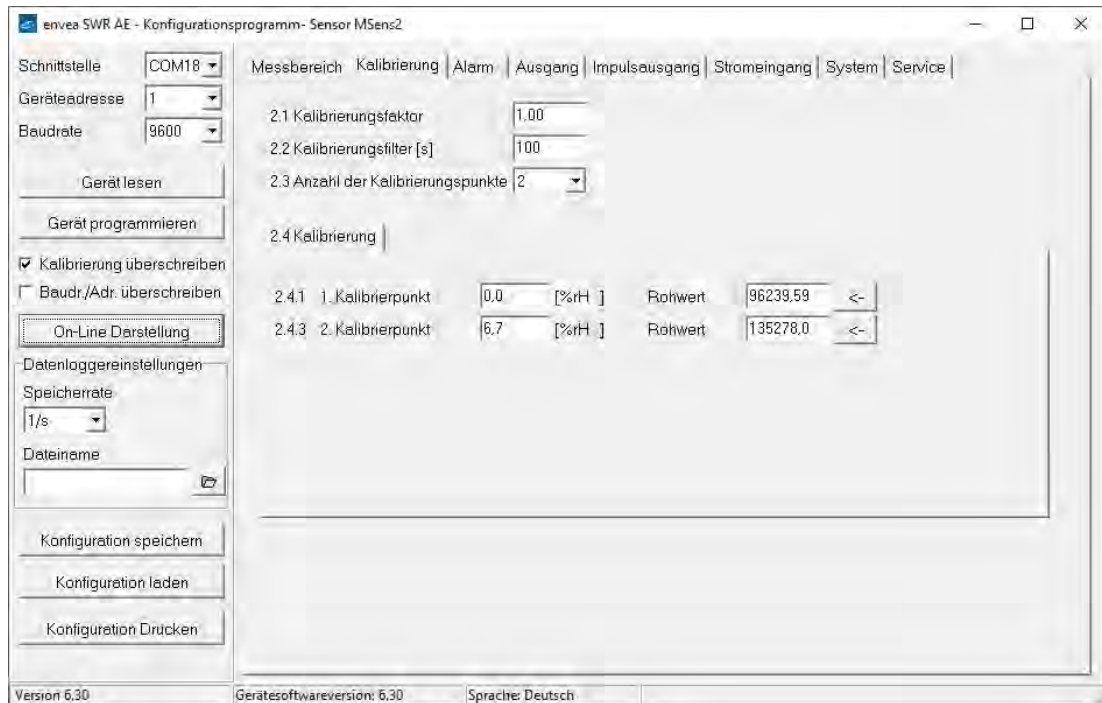

2.1	Calibration factor	Input: 0.01 ... 9.99	Factor for the subsequent adjustment of the actual measurement. All measurements are measured with this factor.
2.2	Calibration filter s	Input: 1 ... 9999	Filter time for recording the raw value during calibration. The raw values already measured over the set time period are combined into an average value.
2.3	Calibration points	Input: 2 ... 5	Number of support points for a linearisation above the operating range.
2.4	Calibration	Calibration submenu	
2.4.1	1. Calibration point	Input:	Output measurement value in the selected measurement value to be shown mass / time unit.
(2.4.2)	P1 calibration	Transfer: Raw value	Transfer the current raw value (filtered) from the mass flow with the key [←]. The value can also be entered manually.
	...	(depending on the number of support points)	For additional support points (depending on [2.3]), additional value pairs can be set.
2.4.n	Pn value	Input: Measurement to be displayed	
2.4.n	Pn calibration	Transfer: Current raw value	

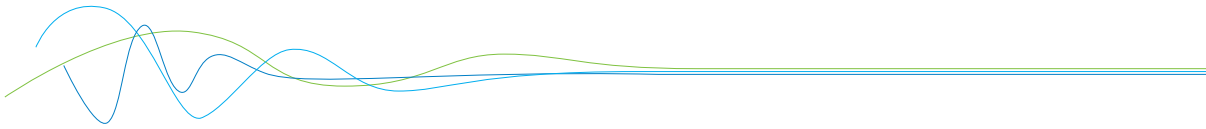

3. Alarm

Setting for the alarm via the relay contacts.

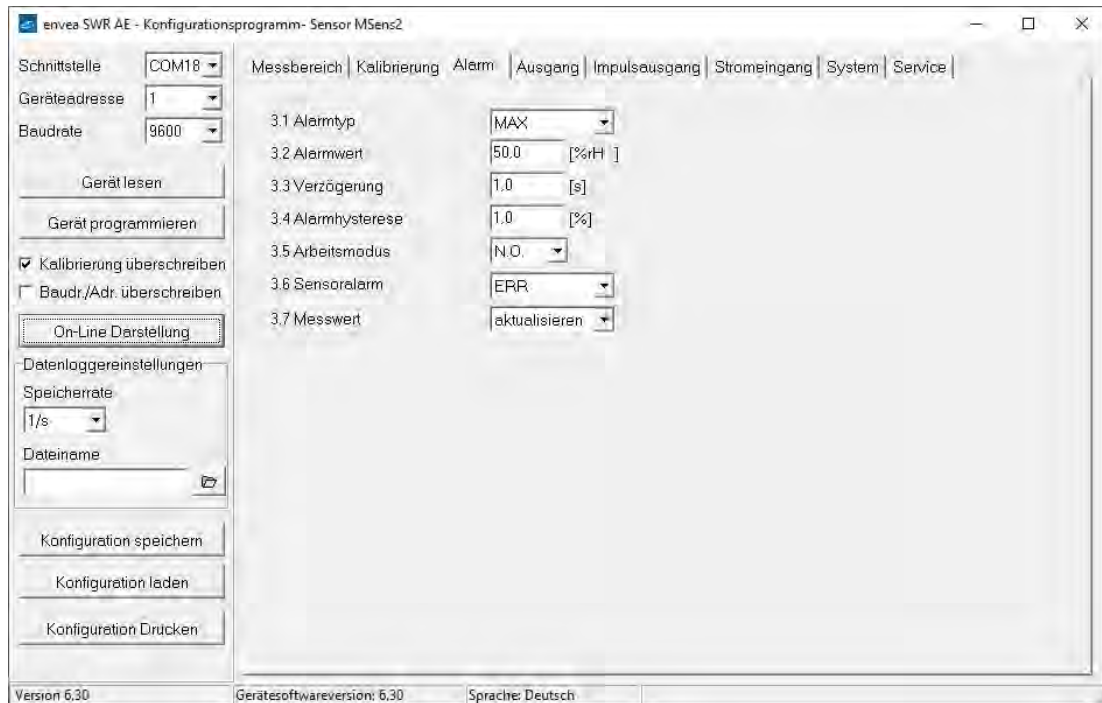

3.1	Alarm type	Selection: None / Min / Max	The relay is activated when the measured value exceeds the max. limit or undershoots the min. limit.
3.2	Alarm value	Input: 0 ... 999.9	Limit value for monitoring Min. or Max.
3.3	Delay	Input: 0.1 ... 99.9 s	The value must permanently exceed or fall below the set limit during this time.
3.4	Hysteresis	Input: 0.1 ... 99.9 %	The alarm continues for as long as the measurement is not smaller or larger than the limit value plus or minus hysteresis.
3.5	Operation mode	Selection: NC / NO	NC: the relay is closed, current principle as no alarm is active. NO: the relay is closed, if there is an alarm.
3.6	Sensor alarm	Selection: OFF /ERR / PROC	Off: Sensor or process indicators are not displayed at the relay. ERR: Serious internal sensor errors trigger an alarm at the relay. PROC: Serious internal sensor errors and process indicators trigger an alarm at the relay. Further information on the signalling levels ERR or PROC can in section entitled Troubleshooting.
3.7	Measurement	Selection: UPDATE / HOLD	Update: In case of alarm, measurement will continue. Hold: In case of alarm, measurement will be on hold until end of alarm.

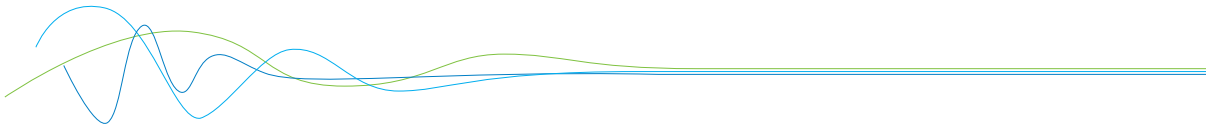

4. Analog output

Setting and calibrating the analogue output.

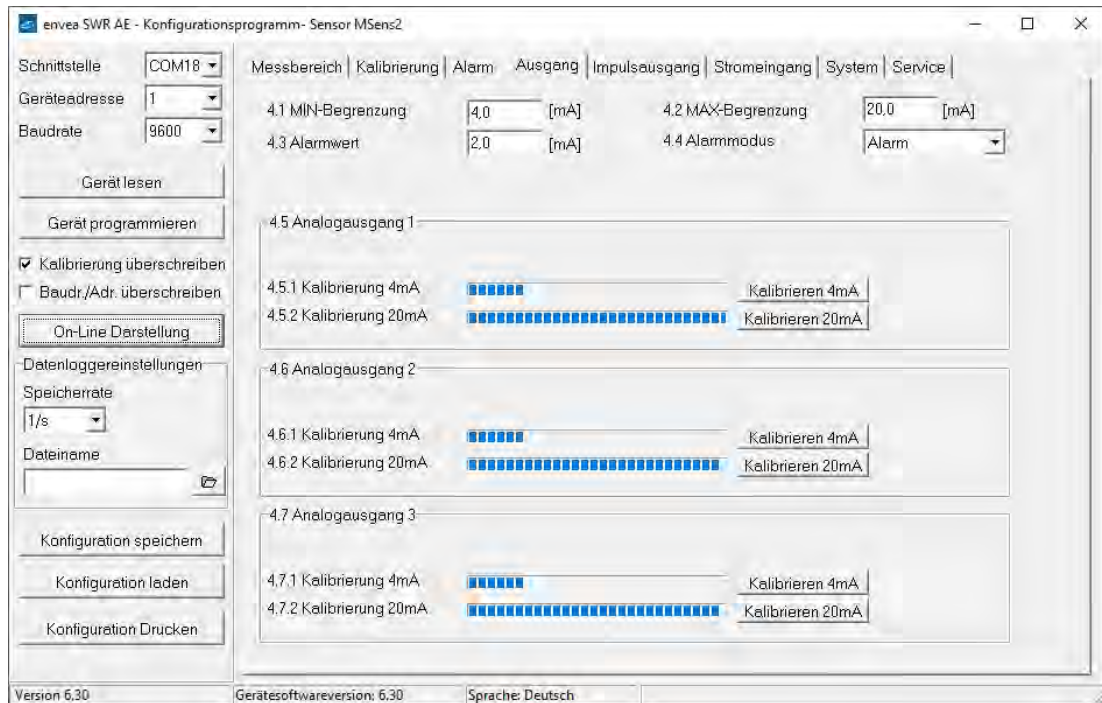

4.1	Lower limit	Input: 0 ... 22 mA	Standard setting: 4 mA
4.2	Upper limit	Input: 0 ... 22 mA	Standard setting: 20 mA
4.3	Alarm value	Input: 0 ... 22 mA	Value to be output at pending alarm (Standard setting 2 mA)
4.4	Alarm mode	Selection: Alarm / Hold output	Alarm: Alarm is output measurement value drops to 0, or current measurement value. Hold output: Last measurement value remains pending until fault rectification at the output signal.
4.5	Analog output 1	Submenu	
4.5.1	Calibration 4 mA	Selection: Setting the output current	Key functions can be used to set the current and equalise it to the receiver side
4.5.2	Calibration 20 mA	Selection: Setting the output current	Key functions can be used to set the current and equalise it to the receiver side
4.6	Analog output 2	Submenu	
4.6.1	Calibration 4 mA	Selection: Setting the output current	Key functions can be used to set the current and equalise it to the receiver side
4.6.2	Calibration 20 mA	Selection: Setting the output current	Key functions can be used to set the current and equalise it to the receiver side

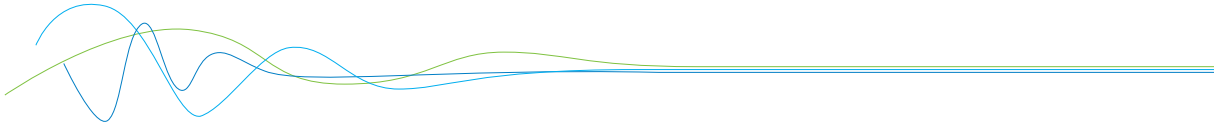

4.7 Analogue output 3 **Submenu**

4.7.1 Calibration 4 mA **Selection:** Key functions can be used to set the current and equalise it to the receiver side
Setting the output current

4.7.2 Calibration 20 mA **Selection:** Key functions can be used to set the current and equalise it to the receiver side
Setting the output current

The current output can be calibrated so that the zero point (output of 4 mA) is set to the background noise of the measuring point. If the background noise decreases due to process changes, sensor wear or other ageing effects, a signal of less than 4 mA can be output at the analogue output. In this way, a zero offset can be detected (zero point drift).

If this function is not desired for process engineering reasons, the zero point must be specified for the calibration to a raw value of zero and/or the **4.1 MIN limit** set to 4 mA.

If the settings of the 4 mA or 20 mA signal are changed, the checkbox **Overwrite calibration** must be set. If the checkbox is set the changed parameters can be sent to the Evaluation unit by clicking on **Device program**.

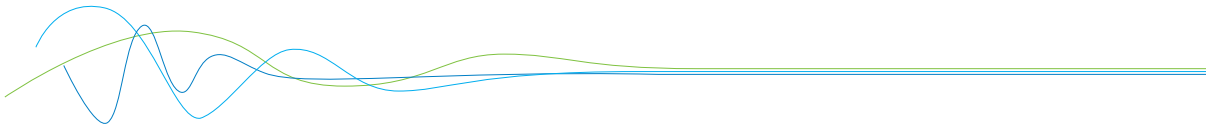

5. Pulse output

Passive signal for pulse cleaning.

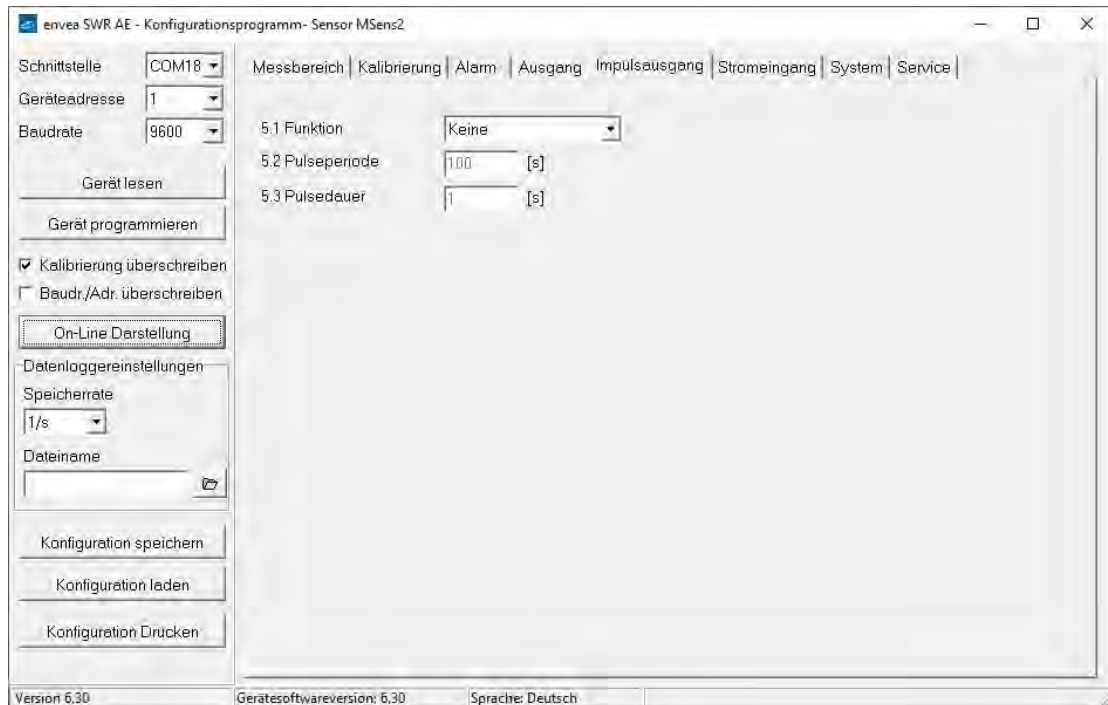

5.1 Function

Selection:
NONE / CLEANING

None: No pulse output
Cleaning: Option for actuation of a solenoid valve for pneumatic air flushing.

5.2 Pulse period

Input: 1 s ... 600 s

Duration between two pulses

5.3 Pulse length

Input: 1 s ... 60 s

Length of the pulse

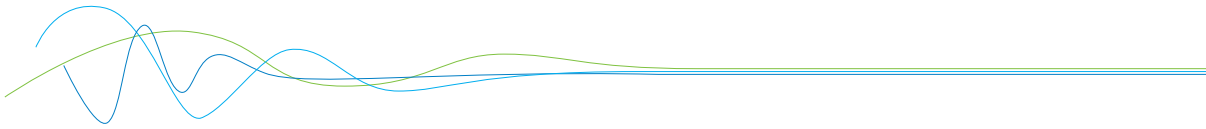

6. Current input

Note: Only available on fieldhousing.

Option for auto-correction by external current signal.

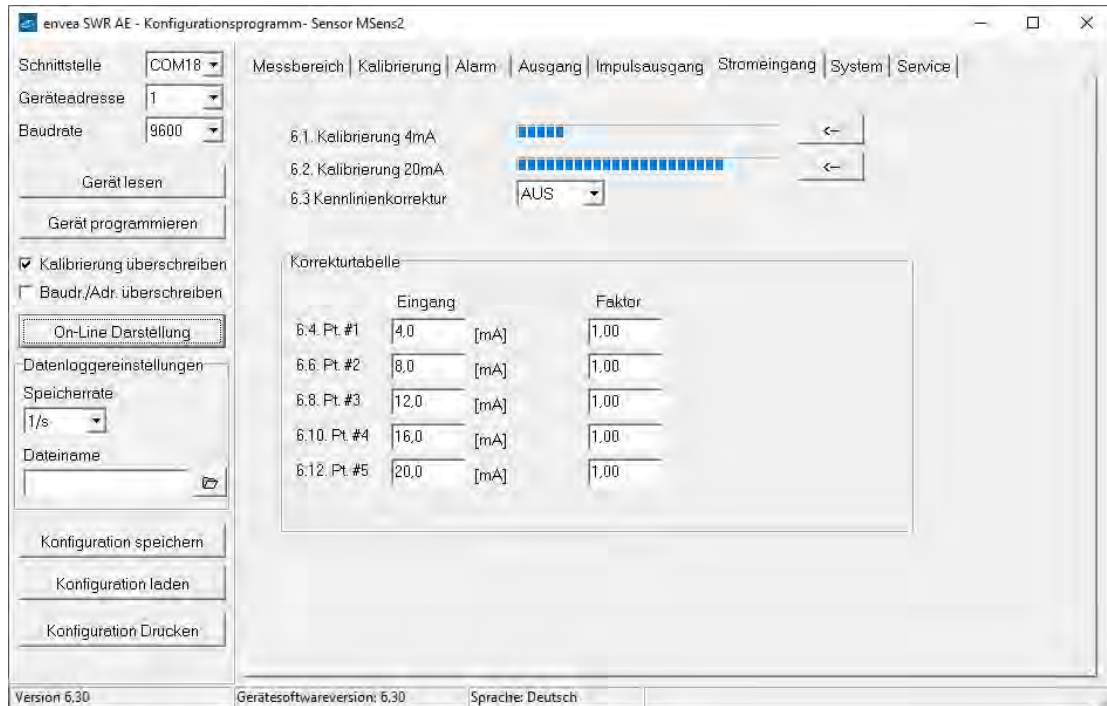

The signal is not electrically isolated.

If the connection is incorrect, the CPU of the Evaluation unit may be destroyed.

An external, galvanic isolation by means of a current disconnecter or similar must be provided.

6.1	Input calib. 4 mA	Selection: Set input current	The 4 mA signal must be read in via key functions.
6.2	Input calib. 20 mA	Selection: Set input current	The 20 mA signal must be read in via key functions.
6.3	Correction	Selection: ON / OFF	ON: Activation of the correction. OFF: Deactivation of the correction.
6.4	P1 input	Input: 4 mA ... 20 mA	Input the current that is to be used for the correction.
6.5	P1 factor	Input: 0.01 ... 10	Factor for subsequent adjustment of the actual measurement value.
6.n	Pn input	Input: 4 mA ... 20 mA	Option for further entry of current value and correction factors.
6.n	Pn factor	Input: 0.01 ... 10	

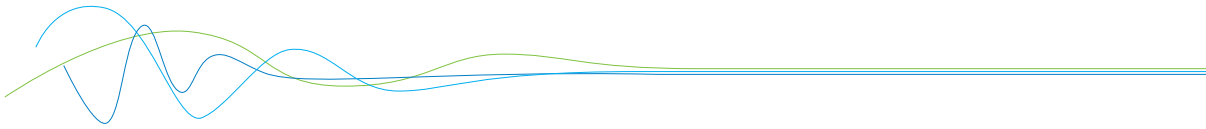

7. System

Basic adjustment of the system and Evaluation unit.

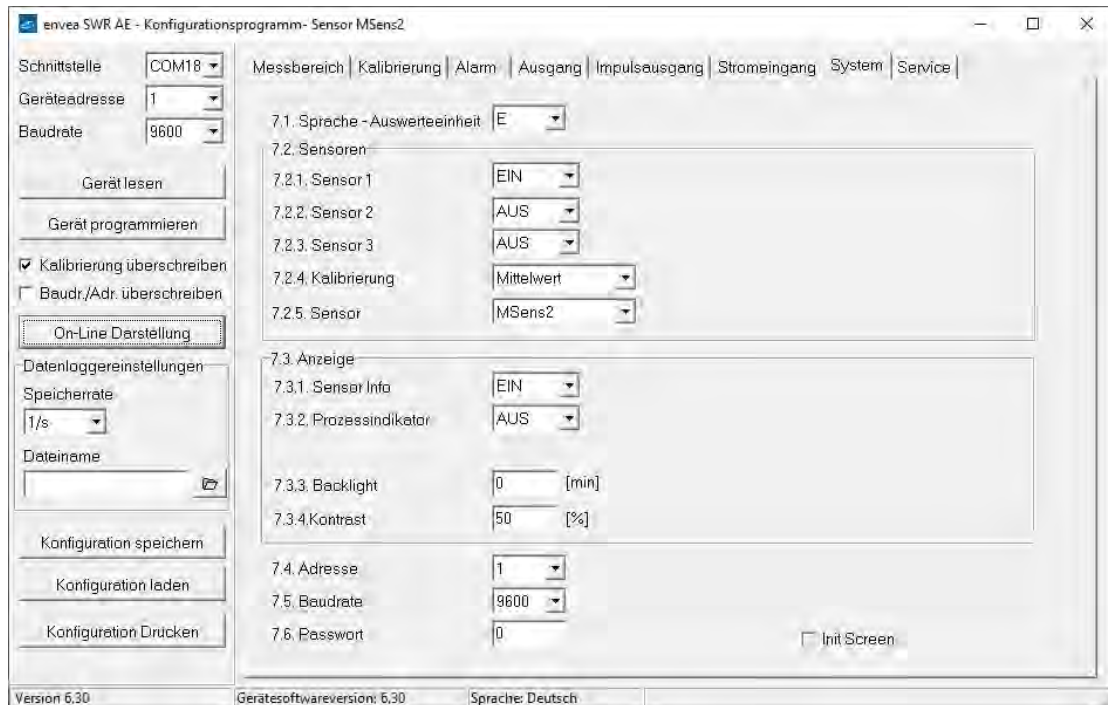

7.1	Language	Selection: D / E / F	Language on the Evaluation unit
7.2	Sensors	Sensor function and calibration	
7.2.1	Sensor 1	Selection: ON / OFF	ON: Sensor is evaluated. OFF: Sensor is ignored.
7.2.2	Sensor 2	Selection: ON / OFF	ON: Sensor is evaluated. OFF: Sensor is ignored.
7.2.3	Sensor 3	Selection: ON / OFF	ON: Sensor is evaluated. OFF: Sensor is ignored.
7.2.4	Calibration	Selection: SINGLE / AVERAGE	This function is used only for multi-sensor systems! Single: Calibration of single sensors: Each sensor is converted via an individual calibration table from the raw value to the throughput, after that the calculation of average throughput on the throughput values of the individual sensors is taking place. (This function should only be used by trained personnel of ENVEA Process.) Average: Calibration by the average value from raw values: The throughput will be calculated with a common calibration table after forming the average from raw values.

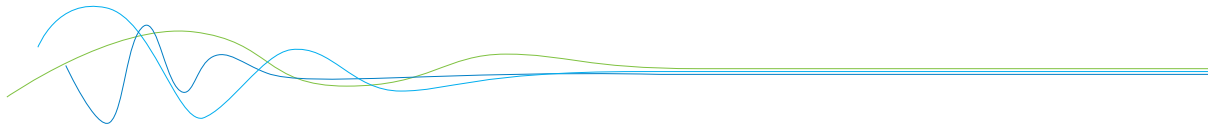

7.2.5	Sensor	Selection: SolidFlow 2.0 / PicoFlow / ProSens / SpeedFlow 2.0 / Paddy / MaxxFlow HTC / DensFlow / SlideControl / M-Sens 2 / M-Sens WR2 / M-Sens 3	The Evaluation unit verifies the availability of registered sensors on the selected type, calculates the measurement values on this basis and signals if necessary corresponding errors. Incorrect sensor selection leads to a refusal to communicate.
7.3.	Display	Submenu	
7.3.1	Sensor info	Selection: ON / OFF	ON: Show info key on display OFF: Hide info key
7.3.2	Process indicator	Selection: ON / OFF	ON: Process indicators will be shown on display and via double blink on the DIN Rail. OFF: Process indicators will not be shown.
7.3.3	Backlight	Input: 0 ... 99 min	Lighting of the Display in minutes 0 = permanent lighting 99 = time selection for lighting
7.3.4	Contrast	Input: 0 ... 100 %	In the case of display exchange, the contrast can be changed via the PC software, if necessary.
7.4	Address	Input: 1 ... 255	ModBusaddress of Evaluation unit, if operated on a PLC or PC as a slave.
7.5	Baud rate	Selection: 4800/9600/19200/ 38400 baud	Communication speed of the Evaluation unit when this is operated as a ModBus slave on a PLC or a PC.
7.6	Password	Input: 0 ... 9999	0000 = No password XXXX = Four-digit password, which is queried when the menu is called up on the display. Automatic lock five minutes after the last display input.

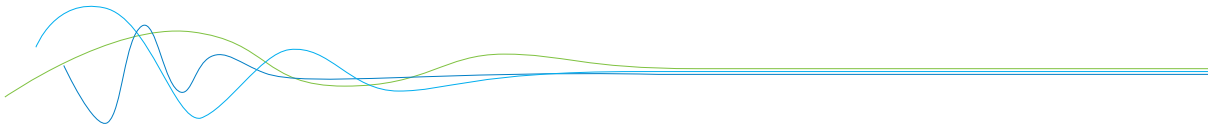

8. Service

Display on the sensor status

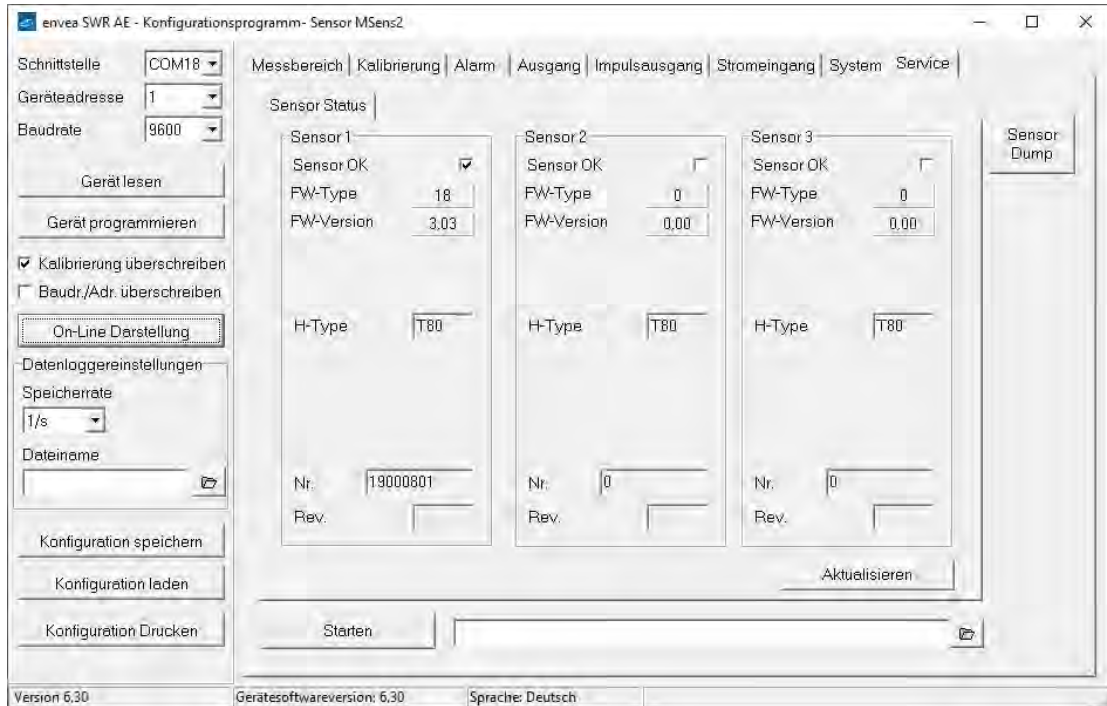

The status of each connected sensor is displayed in menu **8. Service**. FW type, FW version, temperature, serial number and possible hardware errors are automatically read and displayed.

Only according to instructions from personnel of ENVEA Process:

If a detailed error analysis is necessary, a copy of all ModBus registers can be stored as a text file in the installation folder of the software by clicking on the **sensor dump**. This is only possible with the PC software. In addition, a software with deeper access to the sensors can be started via the PC software.

On the touchscreen only the information of the individual sensor will be shown.

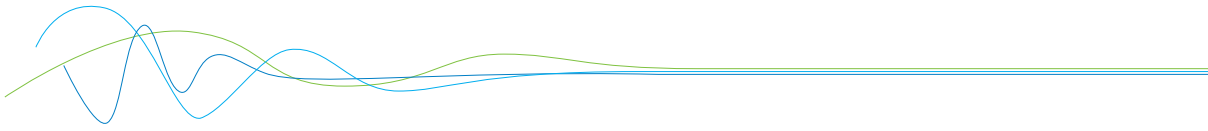

8. Operator interface

The Evaluation unit is a multi-sensor Evaluation unit. It is therefore strongly recommended to check before commissioning whether the correct sensor is selected in menu **System**.

The operator interface differs depending on the system design:

- DIN Rail housing without touchscreen, operation via PC software only
- Field housing with display, operation via PC software or touchscreen

8.1 Differences between the DIN Rail and field housing Evaluation unit

The Evaluation unit in the DIN Rail housing is only a part of the functions available in the field housing. The following overview clarifies the differences between the two versions.

Function	Field housing	DIN Rail
Menu system		
• via PC software	yes	yes
• via display	yes	no
Measurement value display current output	yes	yes
Pulse output for control of solenoid valves	yes	no
Alarm system relay output	yes	yes
Remote control digital input	yes	no
Autocorrect analogue input	yes	no
Error output		
• on current output	yes	yes
• at relay	yes	yes
• via PC software	yes	yes
• via display	yes	no
• on status LED	no	yes

The Evaluation unit in the DIN Rail housing is configured exclusively via a USB connection or RS 485 ModBus connection and a PC program.

For the Evaluation unit in the field housing, all functions can be configured via the touch-sensitive display. The PC configuration is also possible with the Evaluation unit in the field housing.

The menu items on the display and in the PC software are numbered in a uniform manner so that they can be referred to later on.

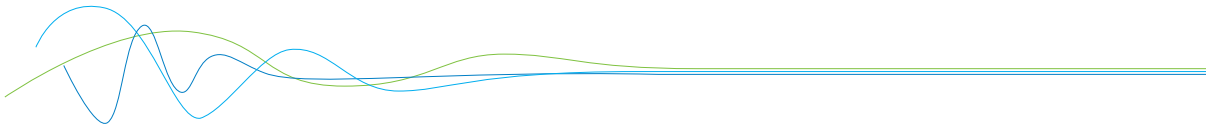

8.2 Display

The display is touch-sensitive. Available keys are displayed directly in context. When the measuring system is first started, a query is initiated to select the language and sensor. If no selection is made, the initialization disappears and the German language with a SolidFlow 2.0 sensor is selected.

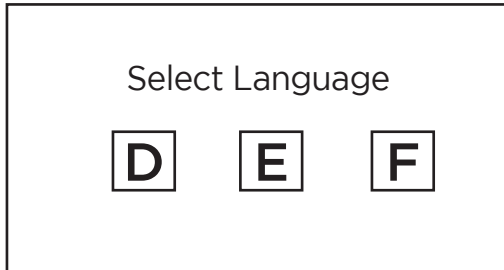

Initialization screen when the Evaluation unit in the field housing started first time.
Selection of the menu language:

Deutsch, English, Français

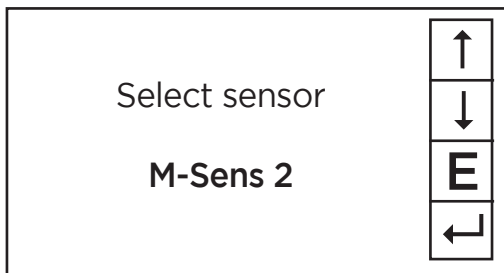

If a language has been selected, the sensor to be used must be selected.

To be available:

SolidFlow 2.0, Paddy, PicoFlow, MaxxFLOW HTC, DensFlow, SpeedFlow 2.0, SlideControl, ProSens, M-Sens 3, M-Sens 2, M-Sens WR2.

Afterwards the start page appears.

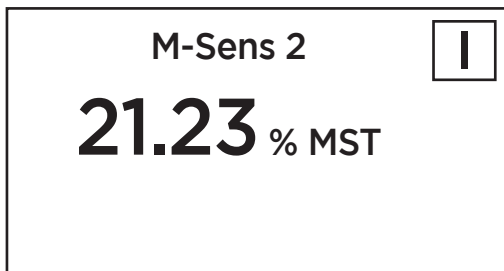

The start page display the following values:

- Name "M-Sens 2", freely selectable text which describes the material or the measuring point
- Measured value, here in % Moisture [% MST]
- [I] key for info

To access the main menu, press and hold any area of the display for several seconds. The sub-menu selection appears.

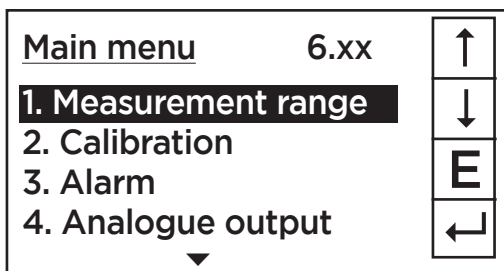

In the menus and input fields, the displayed keys can be used to browse, select, edit or reject:

- [Arrow]: Scroll down the page, Select an option, Select a position in the input text
- [E] for ESC: Interrupt the function without making any changes
- [↵]: Select the function or confirm the input
- [C] for Clear: Delete a symbol or number.

Sensor status			
	Temp	Raw value	Stat
S1	63.0	0.000123	OK
S2	63.0	0.000213	OK

The [I] key can be used to call up an information window, in which the raw value, temperature and status of the sensors can be checked.

Save changes?	
<input type="checkbox"/> Y	<input type="checkbox"/> N

If any data has been changed, the change will only be taken into account when you exit the complete menu structure and answer [Yes] when asked if you wish to save the changes.

For reasons of simplicity, a further display menu screen has been dispensed with. The display screens are directly derived from the menu structure in section 6.4.

Protection against unauthorised use:

If a password has been entered in menu **7. System** in **7.6 Password**, which is different to the “0000” default setting, you will be asked to enter a password when attempting to access the menus. After the password has been successfully entered, the menus will be unlocked for approx. 5 minutes (from the last menu entry).

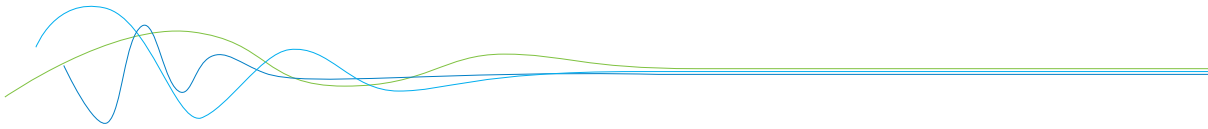

8.3 PC interface

This software is available for download on our website:

<https://www.envea.global/solutions/process-optimization/dahs-software/>

Communication with a laptop or PC is carried out on the DIN Rail as in the field housing version optionally on the terminals via an RS 485 or on the front side via a USB interface.

- ✓ The **RS 485 connection** is attached to the Evaluation unit in the field housing at the ModBus A (+) and ModBus B (-) terminals. On the DIN Rail version, these connections are nos. 12 and 11, accordingly. RS 485 is a bus connection; the ModBus address and the baud rate can be set on the device. Upon delivery, the communication parameters are set to:

8.3.1 ModBus address 1

8.3.2 Baud rate 9600, 8, E,1

An RS 485 to USB adapter can be purchased from ENVEA Process.

- ✓ For the USB connection to the DIN Rail version is a standard USB-A-B cable included. The USB connection is a point-to-point connection that is not BUS-capable. The ModBus address and the baud rate for the front-side connections cannot be changed and are always:

8.3.1 ModBus address 1 (or the device answers to all addresses)

8.3.2 Baud rate 9600, 8, E,1

When connected to the PC for the first time, any interface drivers enclosed with the Evaluation unit must be installed.

After starting the software, the communication parameters must first be entered accordingly. These can be found in the top left of the program window. The COM port to be configured is displayed in the device manager.

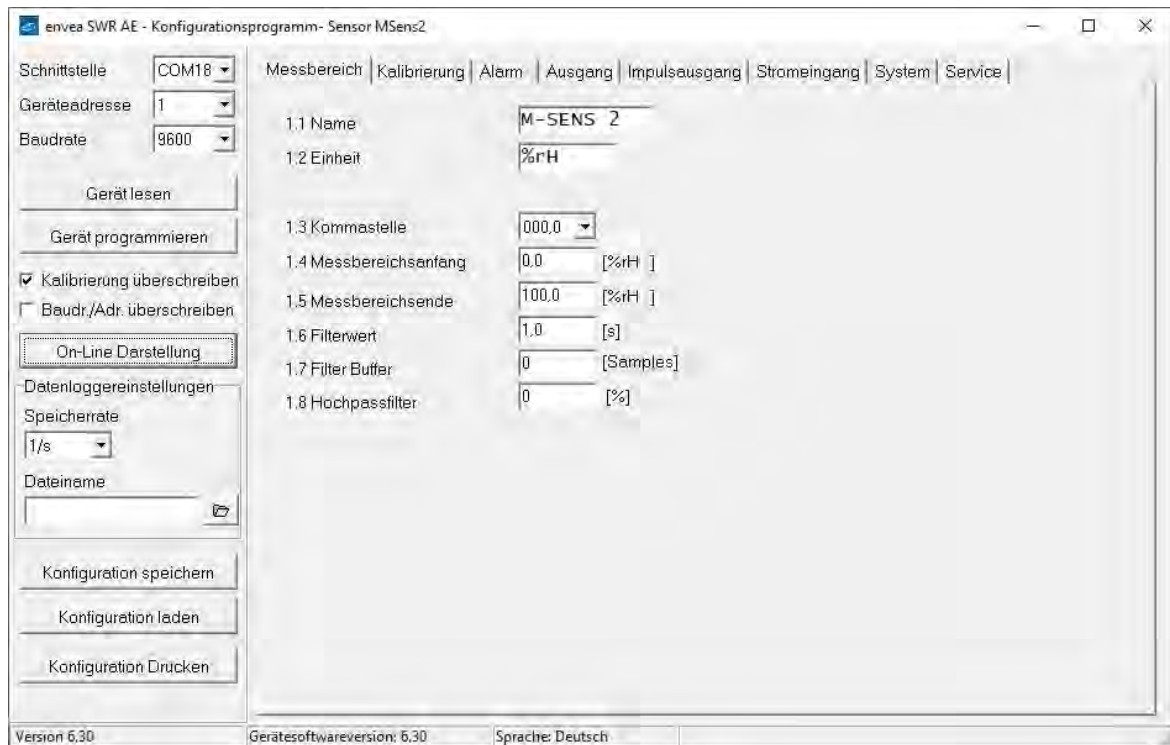

Communication is established by clicking on “Read device”. The acknowledgement message “Parameter read in” is displayed. If an error message is displayed instead, check the communication parameters and cable connections between the PC and the Evaluation unit.

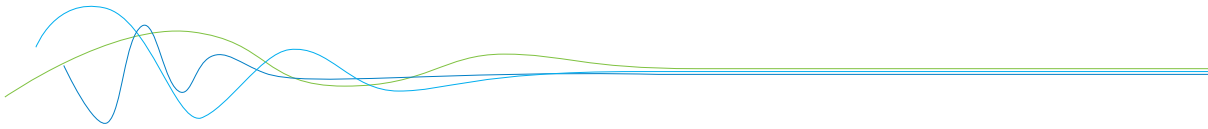

The edited data is transmitted to the Evaluation unit via “Device program”.

Critical data concerning the ModBus communication and the calibration must be confirmed before the parameters are transmitted to the Evaluation unit:

- ✓ If, when saving the parameters in the Evaluation unit, the system calibration data is changed, this action must be confirmed by checking “Overwrite calibration”.
- ✓ If, when saving the parameters in the Evaluation unit, the system interface parameter are changed, this must be confirmed by checking the selection “Overwrite baud r./address”.

8.3.5 On-Line representation

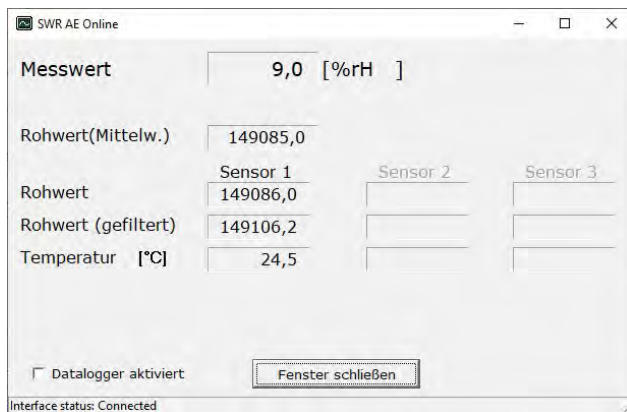

By clicking on “On-Line representation” button you will make a new windows appear.

It will display: Sensor RAW value

- Measured value
- Sensor electronic temperature
- Sensor(s) status
- Noise value

Datalogger is enable when ticked.

In addition, with the PC software,

- the Evaluation unit parameters of the Evaluation unit can be saved in a file (Save configuration)
- the Evaluation unit parameters can be loaded from a file (Load configuration)
- the Evaluation unit parameters can be printed via the Windows standard printer (Print configuration)
- the measured values can be logged in a data logger file (enter the file name and storage rate, and activate the data logger on the online display)

The software language can be set by right-clicking the “Sprache/Language/Langue” field in the bottom program line on “Deutsch/English/Français”.

Protection against unauthorised use:

The PC interface does not have a password prompt as it is assumed that only authorised personnel will have access to the PC and the software. The password to operate the display can be read and changed in menu **7. System** under **7.6 Password**.

9. Maintenance



Warning!

- Electric shock hazard when housing is open!
- Switch off the power supply during all maintenance and repair work on the measuring system. The system may not be in operation for a sensor exchange.
- Repair and maintenance work may only be carried out by qualified electricians.
- The system is maintenance-free.
- The sensor must be removed from the installation place before any welding work in the area.

10. Measurement precision

To ensure high precision of the measurement, following conditions must be respected:

- Stable material density
- Stable material conveying speed
- Homogenous particle size

Please see graphic below for more details about precision:

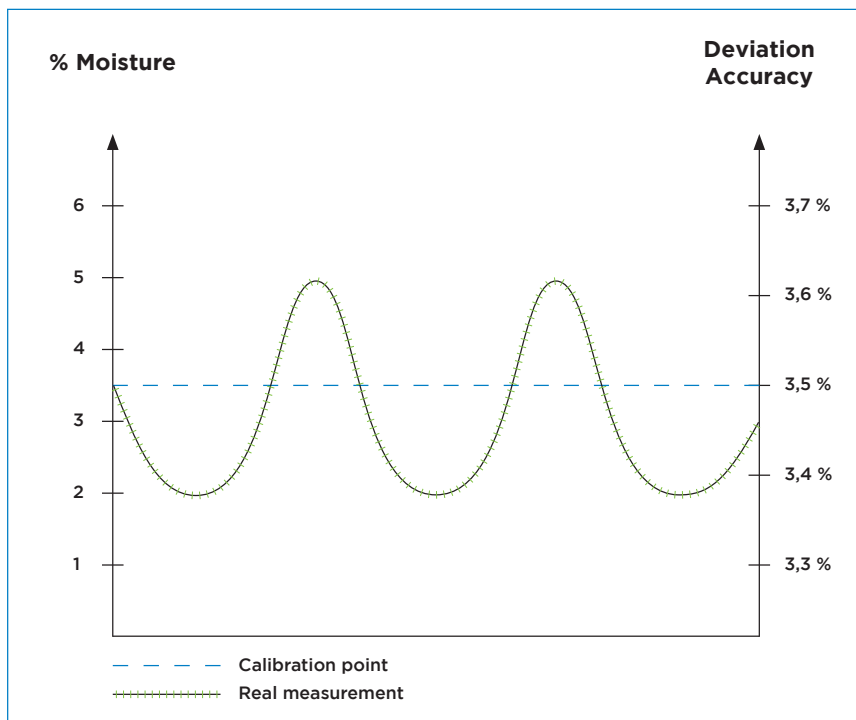

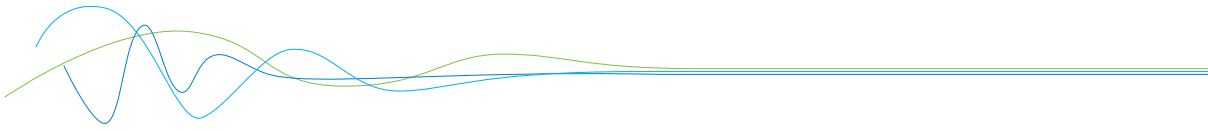

11. Warranty

Warranty is granted for one year starting from delivery date under the condition that the operating instructions have been followed, no interventions on the appliances have been made and the components of the system show no mechanical damage or wear resistance.

In case of a defect during the warranty period, defective components are repaired or are replaced free of charge.

Replaced parts turn into the property of ENVEA Process. If desired by the customer that the parts should be repaired or replaced in its factory, then the customer has to take over the costs for the ENVEA Process-service staff.

ENVEA Process is not responsible for damage, which did not develop at the delivery article; especially ENVEA Process is not responsible for escaped profit or other financial damages of the customer.

12. Troubleshooting



- **Warning!**

The electrical installation must only be checked by expert personnel.

Problem	Cause	Measure
Measuring system does not work. POW LED off.	Power supply interrupted.	Check the power supply.
	Cable break.	Check the connecting cables for a possible break of a cable.
	Defective fuse.	Exchange the fuse.
	Defective device.	Call ENVEA Process for further instructions.
Measuring system does not work. RUN LED off.	Microprocessor does not start.	Power supply switch off and switch on. Program cables remove.
Measuring system outputs wrong values.	Incorrect calibration.	Delete input signal correction, new calibration according to section 6.
	Calibration shifted by abrasion or caking on front end of sensor.	Delete input signal correction, new calibration according to section 6.
Sensor error.	Sensor not properly connected.	Check cable.
	Sensor damaged.	Replace sensor.
	No 24 V DC supply on sensor.	Assure right power supply.
	Voltage drop on the supply line too highly.	Cable cross section check with the help of the length.
Relay flickering.	Hysteresis too small.	Increase hysteresis, check effects caused by external devices.
Do not open, as otherwise the warranty claim expires!		

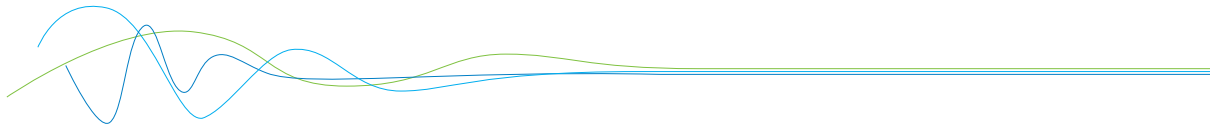

13. Technical data

Sensor	
Housing	Stainless steel 1.4571
Sensor surface	Ceramic
Ex-protection (optional)	Zone 20 (Dust), Zone 0 (Gas)
Protection category	IP67 according to EN 60529
Material ambient temperature	0 ... + 80 °C, optional 120 °C
Working pressure	Max. 10 bar
Power consumption	0.6 W
Responsive time	0.1 sec.
Weight	1.3 kg
Measuring range	0 ... 65 % residual moisture (depending on material)
Accuracy	0.1 % absolutely in the calibrated measuring range
Connection cable	Shielded cable 4-wired, 0.25 mm ²
MSE 300-FH	
Power supply	110/230 V, 50 Hz (optional 24 V DC)
Power consumption	20 W / 24 VA
Protection category	IP65 to EN 60 529/10.91
Ambient operating temperature	-10 ... +45°C
Dimensions	258 x 237 x 174 (W x H x D)
Weight	Approx. 2.5 kg
Interface	RS 485 (ModBus RTU) / USB
Cable screw connectors	3 x M20 (4.5 - 13 mm Ø)
Connection terminals cable cross-section	0.2 - 2.5 mm ² [AWG 24-14]
Current output	3 x 4 ... 20 mA (0 ... 20 mA) load < 500 Ω (Active)
Relay contact	Max. rated load: 250 V AC Max. peak current: 6 A Max. rated load 230 V AC: 250 VA Max. breaking capacity DC1: 3/110/220 V: 3/0.35/0.2 A Min. switching load: 500 mW (10 V/5 mA)
Data backup	Flash memory
Pulse output	Open collector - max. 30 V, 20 mA
MSE 300-DR	
Power supply	24 V DC 3 10 %
Power consumption	20 W / 24 VA
Protection category	IP40 to EN 60 529
Ambient operating temperature	-10 ... +45°C
Dimensions	23 x 90 x 118 (W x H x D)
Weight	Approx. 172 g
Interface	RS 485 (ModBus RTU) / USB
DIN Rail fastening	DIN 60715 TH35
Connection terminals cable cross-section	0.2 - 2.5 mm ² [AWG 24-14]
Current output	1 x 4 ... 20 mA (0 ... 20 mA) load < 500 Ω (Active)
Relay contact	Max. rated load: 250 V AC Max. peak current: 6 A Max. rated load 230 V AC: 250 VA Max. breaking capacity DC1: 3/110/220 V: 3/0.35/0.2 A Min. switching load: 500 mW (10 V/5 mA)
Data backup	Flash memory
Pulse output	Open Collector - Max. 30 V, 20 mA



ENVEA Process GmbH

Gutedelstraße 31 · 79418 Schliengen (Germany)

Fon +49 7635 827248-0 · Fax +49 7635 827248-48 · www.envea.global

PART OF THE ENVEA GROUP



All rights reserved.